

Japanparts®



CATALOGO - CATALOGUE
SENSORI USURA FRENO
BRAKE PADS WEAR SENSORS
2025



www.japanparts.eu

Company

Born over 35 years ago to distribute a complete and quality range of spare parts for Asian vehicles, Japanparts srl stands out today for an increasingly articulated offer covering European and American applications.



JAPANPARTS s.r.l.



Japanparts s.r.l. has been working since 1988 as a leading company in the import and distribution of spare parts for Asian, American and European vehicles.

The company offers a wide range with high quality standards, an efficient logistics, that few companies can boast and a widespread distribution in Italy and abroad.

Wide, deep and quality range

9 families, 158 (product) lines and 69.000 items make up **the complete range of spare parts** offered by Japanparts srl to cover the mechanical, electrical and reconditioning needs of European, Asian and American cars. The offer stands out for its breadth and for the careful selection of suppliers, always chosen on the basis of high-quality standards.

All-round player

The Japanparts srl offer is constantly updated to take into consideration the new needs of **the auto repair sector**, in terms of new products and codes. Japanparts srl presents itself today as an increasingly important company in the aftermarket, capable of competing, in terms of quality and supply, with the best international companies.

An enviable logistics

Each product distributed by Japanparts srl benefits from a timely customer service: **24 hours for the Italian peninsula, 48 hours for the islands** and a maximum of **5 days for abroad**.

All this is made possible by a warehouse with a **storage area** of over **70.000 square meters**, which guarantees the availability of spare parts in each moment.

A widespread distribution

Japanparts srl products are available in Italy thanks to agreements with over **50 distribution partners**. Japanparts srl has a strong market breakthrough also abroad, with more than **400 partner companies** in the main geographical areas on a global level.

Our company has been certified ISO 9001:2015 for its advanced logistics, as evidence of the high efficiency achieved. All our processes follow strict protocols that ensure an excellent and timely service to all our customers.

Azienda

Nata oltre 35 anni fa per distribuire una gamma completa e di qualità di ricambi per veicoli asiatici, Japanparts srl si distingue oggi per un'offerta sempre più articolata a copertura di applicazioni europee e americane.

JAPANPARTS s.r.l.



Japanparts S.r.l. opera dal 1988 come azienda leader nel settore dell'importazione e distribuzione di ricambi per veicoli asiatici, americani ed europei.

L'azienda offre gamme ampie, pofonde e dagli elevati standard qualitativi. Una logistica efficiente che poche aziende possono vantare ed una distribuzione capillare in Italia e all'estero.

Gamme ampie, profonde e di qualità

9 famiglie, 158 linee e circa 69.000 codici prodotto compongono **la gamma completa di ricambi** offerti da Japanparts S.r.l. per coprire le esigenze meccaniche, elettriche e di rettifica di vetture europee, asiatiche e americane. L'offerta si distingue per ampiezza, profondità e per l'accurata selezione dei fornitori, scelti sempre in base agli elevati standard qualitativi.

Player a tutto tondo

L'offerta di Japanparts S.r.l. viene costantemente aggiornata per tener conto delle nuove esigenze del settore **della riparazione auto**, sia in termini di nuovi prodotti sia codici. Japanparts S.r.l. si presenta oggi come un'azienda sempre più importante dell'aftermarket, capace di competere, per qualità e offerta, con le migliori realtà internazionali.

Una logistica invidiabile

Ogni prodotto distribuito da Japanparts S.r.l. beneficia di un servizio al cliente tempestivo: **24 ore per la penisola, 48 ore per le isole e massimo 5 giorni per l'estero.**

Tutto ciò è reso possibile da un **magazzino** con una superficie di stoccaggio di oltre **70.000 mq.** che garantisce in ogni momento la disponibilità dei ricambi.

Una distribuzione capillare

I prodotti di Japanparts S.r.l. sono disponibili in Italia grazie ad accordi con oltre **50 partner distributivi.** Japanparts S.r.l. ha una forte penetrazione commerciale anche all'estero, con più di **400 aziende partner** nelle principali aree geografiche a livello globale.

La nostra azienda è stata certificata ISO 9001:2015 per la sua evoluta logistica, a testimonianza dell'elevata efficienza raggiunta. Tutti i nostri processi seguono rigidi protocolli che assicurano un servizio eccellente e tempestivo a tutta la nostra clientela.



Japanparts®



APPLICAZIONE (APPLICATION)	ANNO (YEAR)	CODICE (CODE)	LATO (SIDE)	O.E. (OR. NUMBER)	LUNGH. (LENGHT)
A3 (8V1 - 8VK) A3 CABRIO (8V7 - 8VE)	05/13 > 10/20	BPW-312	ANTERIORE (FRONT)	8V0615437	170 mm.
A3 LIMOUSINE (8VS - 8VM) A3 LIMOUSINE (8YS - 8YM)	05/13 >	BPW-312	ANTERIORE (FRONT)	8V0615437	170 mm.
A3 SPORTBACK (8VA - 8VF)	05/13 > 10/20	BPW-312	ANTERIORE (FRONT)	8V0615437	170 mm.
A3 SPORTBACK (8YA - 8YF)	11/19 >	BPW-312	ANTERIORE (FRONT)	8V0615437	170 mm.
A4 (B8) A4 AVANT (B8)	01/08 > 12/15	BPW-006	ANTERIORE (FRONT)	8K0615121 4G0615121B	300 mm.
A4 (B8) A4 AVANT (B8)	01/08 > 12/15	BPW-300	POSTERIORE (REAR)	4G0615121	215 mm.
A4 (B9) A4 AVANT (B9)	08/15 >	BPW-031	ANTERIORE (FRONT)	4M0615121R 4M0615121S 4M0615121AB	400 mm.
A4 (B9) A4 AVANT (B9)	08/15 >	BPW-083	ANTERIORE (FRONT)	8W0615121H	280 mm.
A4 (B9) A4 AVANT (B9)	08/15 >	BPW-313	POSTERIORE (REAR)	8W0615121E	390 mm.
A5 (8T3)	06/07 > 01/17	BPW-006	ANTERIORE (FRONT)	8K0615121 4G0615121B	300 mm.
A5 (F53 - F5P) A5 CABRIO (F57 - F5E)	06/16 >	BPW-031	ANTERIORE (FRONT)	4M0615121R 4M0615121S 4M0615121AB	400 mm.
A5 (F53 - F5P) A5 CABRIO (F57 - F5E)	06/16 >	BPW-083	ANTERIORE (FRONT)	8W0615121H	280 mm.
A5 (F53 - F5P) A5 CABRIO (F57 - F5E)	06/16 >	BPW-313	POSTERIORE (REAR)	8W0615121E	390 mm.
A5 SPORTBACK (8TA)	09/09 > 01/17	BPW-006	ANTERIORE (FRONT)	8K0615121 4G0615121B	300 mm.
A5 SPORTBACK (F5A - F5F)	09/16 >	BPW-031	ANTERIORE (FRONT)	4M0615121R 4M0615121S 4M0615121AB	400 mm.
A5 SPORTBACK (F5A - F5F)	09/16 >	BPW-313	POSTERIORE (REAR)	8W0615121E	390 mm.

APPLICAZIONE (APPLICATION)	ANNO (YEAR)	CODICE (CODE)	LATO (SIDE)	O.E. (OR. NUMBER)	LUNGH. (LENGHT)
A6 (C7) A6 AVANT (C7)	11/10 > 09/18	BPW-006	ANTERIORE (FRONT)	8K0615121 4G0615121B	300 mm.
A6 (C7) A6 AVANT (C7)	11/10 > 09/18	BPW-051	ANTERIORE (FRONT)	4H0615121E 4H0615121F 4H0615121J	311 mm.
A6 (C7) A6 AVANT (C7)	11/10 > 09/18	BPW-098	ANTERIORE (FRONT)	8R0615121A 4G0615121C	361 mm.
A6 (C7) A6 AVANT (C7)	11/10 > 09/18	BPW-149	ANTERIORE (FRONT)	4H0615121 4H0615121P 4G0615121E	225 mm.
A6 (C7) A6 AVANT (C7)	11/10 > 09/18	BPW-185	POSTERIORE (REAR)	4H0615121B 4H0615121Q	450 mm.
A6 (C7) A6 AVANT (C7)	11/10 > 09/18	BPW-300	POSTERIORE (REAR)	4G0615121	215 mm.
A6 (C8) A6 AVANT (C8)	02/18 >	BPW-031	ANTERIORE (FRONT)	4M0615121R 4M0615121S 4M0615121AB	400 mm.
A6 (C8) A6 AVANT (C8)	02/18 >	BPW-083	ANTERIORE (FRONT)	8W0615121H	280 mm.
A6 (C8) A6 AVANT (C8)	02/18 >	BPW-185	POSTERIORE (REAR)	4H0615121B 4H0615121Q	450 mm.
A6 (C8) A6 AVANT (C8)	02/18 >	BPW-314	POSTERIORE (REAR)	80A615121	345 mm.
A7 SPORTBACK (4GA - 4GF)	10/10 > 05/18	BPW-006	ANTERIORE (FRONT)	8K0615121 4G0615121B	300 mm.
A7 SPORTBACK (4GA - 4GF)	10/10 > 05/18	BPW-098	ANTERIORE (FRONT)	8R0615121A 4G0615121C	361 mm.
A7 SPORTBACK (4GA - 4GF)	10/10 > 05/18	BPW-185	POSTERIORE (REAR)	4H0615121B 4H0615121Q	450 mm.
A7 SPORTBACK (4GA - 4GF)	10/10 > 05/18	BPW-300	POSTERIORE (REAR)	4G0615121	215 mm.
A7 SPORTBACK (4KA)	07/18 >	BPW-031	ANTERIORE (FRONT)	4M0615121R 4M0615121S 4M0615121AB	400 mm.
A7 SPORTBACK (4KA)	07/18 >	BPW-051	ANTERIORE (FRONT)	4H0615121E 4H0615121F 4H0615121J	311 mm.

APPLICAZIONE (APPLICATION)	ANNO (YEAR)	CODICE (CODE)	LATO (SIDE)	O.E. (OR. NUMBER)	LUNGH. (LENGHT)
A7 SPORTBACK (4KA)	07/18 >	BPW-083	ANTERIORE (FRONT)	8W0615121H	280 mm.
A7 SPORTBACK (4KA)	07/18 >	BPW-185	POSTERIORE (REAR)	4H0615121B 4H0615121Q	450 mm.
A7 SPORTBACK (4KA)	07/18 >	BPW-314	POSTERIORE (REAR)	80A615121	345 mm.
A8 (D4)	11/09 > 01/18	BPW-051	ANTERIORE (FRONT)	4H0615121E 4H0615121F 4H0615121J	311 mm.
A8 (D4)	11/09 > 01/18	BPW-149	ANTERIORE (FRONT)	4H0615121 4H0615121P 4G0615121E	225 mm.
A8 (D4)	11/09 > 01/18	BPW-185	POSTERIORE (REAR)	4H0615121B 4H0615121Q	450 mm.
A8 (D5)	06/17 >	BPW-031	ANTERIORE (FRONT)	4M0615121R 4M0615121S 4M0615121AB	400 mm.
A8 (D5)	06/17 >	BPW-041	POSTERIORE (REAR)	4M0615121P 8W0615121E	390 mm.
A8 (D5)	06/17 >	BPW-314	POSTERIORE (REAR)	80A615121	345 mm.
E-TRON (T.T.)	09/18 >	BPW-031	ANTERIORE (FRONT)	4M0615121R 4M0615121S 4M0615121AB	400 mm.
E-TRON (T.T.)	09/18 >	BPW-314	POSTERIORE (REAR)	80A615121	345 mm.
Q2 (GAB - GAG)	06/16 >	BPW-312	ANTERIORE (FRONT)	8V0615437	170 mm.
Q3 (F3B) Q3 SPORTBACK (F3N)	07/18 >	BPW-312	ANTERIORE (FRONT)	8V0615437	170 mm.
Q5 (8RB)	06/12 > 05/17	BPW-006	ANTERIORE (FRONT)	8K0615121 4G0615121B	300 mm.
Q5 (8RB)	06/12 > 05/17	BPW-051	ANTERIORE (FRONT)	4H0615121E 4H0615121F 4H0615121J	311 mm.
Q5 (8RB)	06/12 > 05/17	BPW-098	ANTERIORE (FRONT)	8R0615121A 4G0615121C	361 mm.

APPLICAZIONE (APPLICATION)	ANNO (YEAR)	CODICE (CODE)	LATO (SIDE)	O.E. (OR. NUMBER)	LUNGH. (LENGHT)
Q5 (FYB - FYG)	06/16 >	BPW-031	ANTERIORE (FRONT)	4M0615121R 4M0615121S 4M0615121AB	400 mm.
Q5 (FYB - FYG)	06/16 >	BPW-083	ANTERIORE (FRONT)	8W0615121H	280 mm.
Q5 (FYB - FYG)	06/16 >	BPW-169	ANTERIORE (FRONT)	80A615121A	290 mm.
Q5 (FYB - FYG)	06/16 >	BPW-314	POSTERIORE (REAR)	80A615121	345 mm.
Q5 SPORTBACK (FYT)	11/20 >	BPW-031	ANTERIORE (FRONT)	4M0615121R 4M0615121S 4M0615121AB	400 mm.
Q5 SPORTBACK (FYT)	11/20 >	BPW-083	ANTERIORE (FRONT)	8W0615121H	280 mm.
Q5 SPORTBACK (FYT)	11/20 >	BPW-169	ANTERIORE (FRONT)	80A615121A	290 mm.
Q5 SPORTBACK (FYT)	11/20 >	BPW-314	POSTERIORE (REAR)	80A615121	345 mm.
Q7 (4LB)	03/06 > 08/15	BPW-014	ANTERIORE (FRONT)	7L0907637 8J0615437	420 mm.
Q7 (4LB)	03/06 > 08/15	BPW-021	POSTERIORE (REAR)	7L0907637B 7L0907637C	255 mm.
Q7 (4MB - 4MG - 4MQ)	01/15 >	BPW-031	ANTERIORE (FRONT)	4M0615121R 4M0615121S 4M0615121AB	400 mm.
Q7 (4MB - 4MG - 4MQ)	01/15 >	BPW-041	POSTERIORE (REAR)	4M0615121P 8W0615121E	390 mm.
Q8 (4MN - 4MT)	02/18 >	BPW-031	ANTERIORE (FRONT)	4M0615121R 4M0615121S 4M0615121AB	400 mm.
Q8 (4MN - 4MT)	02/18 >	BPW-041	POSTERIORE (REAR)	4M0615121P 8W0615121E	390 mm.
TT (8N3) TT ROADSTER (8N9)	07/03 > 06/06	BPW-184	ANTERIORE (FRONT)	1J0615121	270 mm.
TT (FV3 - FVP) TT ROADSTER (FV9 - FVR)	07/14 >	BPW-310	ANTERIORE (FRONT)	8S0615121A	200 mm.

APPLICAZIONE (APPLICATION)	ANNO (YEAR)	CODICE (CODE)	LATO (SIDE)	O.E. (OR. NUMBER)	LUNGH. (LENGHT)
i3 (I01)	08/13 >	BPW-137	ANTERIORE (FRONT)	34356799329	679 mm.
i4 (G26)	11/21 >	BPW-298	ANTERIORE (FRONT)	34356870354	795 mm.
i4 (G26)	11/21 >	BPW-299	ANTERIORE (FRONT)	34356870349	760 mm.
IX (I20)	07/21 >	BPW-309	ANTERIORE (FRONT)	34356891369	880 mm.
SERIE 1 (E81 - E87)	09/06 > 12/11	BPW-037	ANTERIORE (FRONT)	34356762252 34356789439	640 mm.
SERIE 1 (E81 - E87)	09/06 > 12/11	BPW-045	ANTERIORE (FRONT)	34356777649 34356789440	690 mm.
SERIE 1 (E81 - E87)	09/06 > 12/11	BPW-076	ANTERIORE (FRONT)	34356792559	650 mm.
SERIE 1 (E81 - E87)	09/06 > 12/11	BPW-088	ANTERIORE (FRONT)	34356792560	723 mm.
SERIE 1 (E81 - E87)	09/06 > 12/11	BPW-028	POSTERIORE (REAR)	34356762253 34356789445	1098 mm.
SERIE 1 (E81 - E87)	09/06 > 12/11	BPW-063	POSTERIORE (REAR)	34356792564	1107 mm.
SERIE 1 CABRIO (E88) SERIE 1 COUPE' (E82)	12/07 > 12/13	BPW-037	ANTERIORE (FRONT)	34356762252 34356789439	640 mm.
SERIE 1 CABRIO (E88) SERIE 1 COUPE' (E82)	12/07 > 12/13	BPW-045	ANTERIORE (FRONT)	34356777649 34356789440	690 mm.
SERIE 1 CABRIO (E88) SERIE 1 COUPE' (E82)	12/07 > 12/13	BPW-076	ANTERIORE (FRONT)	34356792559	650 mm.
SERIE 1 CABRIO (E88) SERIE 1 COUPE' (E82)	12/07 > 12/13	BPW-088	ANTERIORE (FRONT)	34356792560	723 mm.
SERIE 1 CABRIO (E88) SERIE 1 COUPE' (E82)	12/07 > 12/13	BPW-028	POSTERIORE (REAR)	34356762253 34356789445	1098 mm.
SERIE 1 CABRIO (E88) SERIE 1 COUPE' (E82)	12/07 > 12/13	BPW-063	POSTERIORE (REAR)	34356792564	1107 mm.

N.B.: I CODICI O.E. ED IL LORO TESTO SONO RIPORTATI SOLO A TITOLO INDICATIVO
THE O.E. CODES AND THEIR TEXT ARE REPORTED ONLY FOR INDICATIVE PURPOSE

APPLICAZIONE (APPLICATION)	ANNO (YEAR)	CODICE (CODE)	LATO (SIDE)	O.E. (OR. NUMBER)	LUNGH. (LENGHT)
SERIE 1 (F20 - F21)	07/11 > 12/19	BPW-008	ANTERIORE (FRONT)	34356792289	300 mm.
SERIE 1 (F20 - F21)	07/11 > 12/19	BPW-010	POSTERIORE (REAR)	34356792292	1045 mm.
SERIE 1 (F40)	07/19 >	BPW-015	ANTERIORE (FRONT)	34356888167 34356865613 34351543830	655 mm.
SERIE 1 (F40)	07/19 >	BPW-011	POSTERIORE (REAR)	34356865612 34356799736	655 mm.
SERIE 2 (F22 - F23)	03/14 > 06/21	BPW-008	ANTERIORE (FRONT)	34356792289	300 mm.
SERIE 2 (F22 - F23)	03/14 > 06/21	BPW-010	POSTERIORE (REAR)	34356792292	1045 mm.
SERIE 2 ACTIVE TOURER (F45)	11/13 > 10/21	BPW-015	ANTERIORE (FRONT)	34356888167 34356865613 34351543830	655 mm.
SERIE 2 ACTIVE TOURER (F45)	11/13 > 10/21	BPW-011	POSTERIORE (REAR)	34356865612 34356799736	655 mm.
SERIE 2 GRAN COUPE' (F44)	11/19 >	BPW-015	ANTERIORE (FRONT)	34356888167 34356865613 34351543830	655 mm.
SERIE 2 GRAN COUPE' (F44)	11/19 >	BPW-011	POSTERIORE (REAR)	34356865612 34356799736	655 mm.
SERIE 2 GRAN TOURER (F46)	08/14 >	BPW-015	ANTERIORE (FRONT)	34356888167 34356865613 34351543830	655 mm.
SERIE 2 GRAN TOURER (F46)	08/14 >	BPW-011	POSTERIORE (REAR)	34356865612 34356799736	655 mm.
SERIE 2 COUPE' (G42 - G87)	08/21 >	BPW-298	ANTERIORE (FRONT)	34356870354	795 mm.
SERIE 2 COUPE' (G42 - G87)	08/21 >	BPW-299	ANTERIORE (FRONT)	34356870349	760 mm.
SERIE 3 (E30) T.T. SERIE 3 TOURING (E30)	09/83 > 12/91	BPW-217	ANTERIORE (FRONT)	34351153964 34359058889	235 mm.
SERIE 3 (E30) T.T. SERIE 3 TOURING (E30)	09/83 > 12/91	BPW-119	POSTERIORE (REAR)	34111152607 34351180782 34351179819	262 mm.

APPLICAZIONE (APPLICATION)	ANNO (YEAR)	CODICE (CODE)	LATO (SIDE)	O.E. (OR. NUMBER)	LUNGH. (LENGHT)
SERIE 3 (E36) T.T. SERIE 3 TOURING (E36)	09/90 > 08/00	BPW-126	ANT. - POST. (FRONT - REAR)	34351181337 34351181338	776 mm.
SERIE 3 (E36) T.T. SERIE 3 TOURING (E36)	09/90 > 08/00	BPW-203	POSTERIORE (REAR)	34351181342 34351181344	790 mm.
SERIE 3 (E46) T.T.	12/97 > 02/05	BPW-039	ANTERIORE (FRONT)	34351164371	596 mm.
SERIE 3 (E46) T.T.	12/97 > 02/05	BPW-131	ANTERIORE (FRONT)	34356751311	650 mm.
SERIE 3 (E46) T.T.	12/97 > 02/05	BPW-040	POSTERIORE (REAR)	34351164372 34352229780	1340 mm.
SERIE 3 (E90)	12/04 > 12/11	BPW-037	ANTERIORE (FRONT)	34356762252 34356789439	640 mm.
SERIE 3 (E90)	12/04 > 12/11	BPW-045	ANTERIORE (FRONT)	34356777649 34356789440	690 mm.
SERIE 3 (E90)	12/04 > 12/11	BPW-062	ANTERIORE (FRONT)	34356792561	867 mm.
SERIE 3 (E90)	12/04 > 12/11	BPW-076	ANTERIORE (FRONT)	34356792559	650 mm.
SERIE 3 (E90)	12/04 > 12/11	BPW-088	ANTERIORE (FRONT)	34356792560	723 mm.
SERIE 3 (E90)	12/04 > 12/11	BPW-128	ANTERIORE (FRONT)	34356764851 34356777650 34356789441	850 mm.
SERIE 3 (E90)	12/04 > 12/11	BPW-028	POSTERIORE (REAR)	34356762253 34356789445	1098 mm.
SERIE 3 (E90)	12/04 > 12/11	BPW-063	POSTERIORE (REAR)	34356792564	1107 mm.
SERIE 3 CABRIO (E93) SERIE 3 COUPE' (E92)	03/06 > 12/13	BPW-037	ANTERIORE (FRONT)	34356762252 34356789439	640 mm.
SERIE 3 CABRIO (E93) SERIE 3 COUPE' (E92)	03/06 > 12/13	BPW-045	ANTERIORE (FRONT)	34356777649 34356789440	690 mm.
SERIE 3 CABRIO (E93) SERIE 3 COUPE' (E92)	03/06 > 12/13	BPW-062	ANTERIORE (FRONT)	34356792561	867 mm.

APPLICAZIONE (APPLICATION)	ANNO (YEAR)	CODICE (CODE)	LATO (SIDE)	O.E. (OR. NUMBER)	LUNGH. (LENGHT)
SERIE 3 CABRIO (E93) SERIE 3 COUPE' (E92)	03/06 > 12/13	BPW-076	ANTERIORE (FRONT)	34356792559	650 mm.
SERIE 3 CABRIO (E93) SERIE 3 COUPE' (E92)	03/06 > 12/13	BPW-088	ANTERIORE (FRONT)	34356792560	723 mm.
SERIE 3 CABRIO (E93) SERIE 3 COUPE' (E92)	03/06 > 12/13	BPW-128	ANTERIORE (FRONT)	34356764851 34356777650 34356789441	850 mm.
SERIE 3 CABRIO (E93) SERIE 3 COUPE' (E92)	03/06 > 12/13	BPW-028	POSTERIORE (REAR)	34356762253 34356789445	1098 mm.
SERIE 3 CABRIO (E93) SERIE 3 COUPE' (E92)	03/06 > 12/13	BPW-063	POSTERIORE (REAR)	34356792564	1107 mm.
SERIE 3 TOURING (E91)	12/04 > 12/12	BPW-037	ANTERIORE (FRONT)	34356762252 34356789439	640 mm.
SERIE 3 TOURING (E91)	12/04 > 12/12	BPW-045	ANTERIORE (FRONT)	34356777649 34356789440	690 mm.
SERIE 3 TOURING (E91)	12/04 > 12/12	BPW-062	ANTERIORE (FRONT)	34356792561	867 mm.
SERIE 3 TOURING (E91)	12/04 > 12/12	BPW-076	ANTERIORE (FRONT)	34356792559	650 mm.
SERIE 3 TOURING (E91)	12/04 > 12/12	BPW-088	ANTERIORE (FRONT)	34356792560	723 mm.
SERIE 3 TOURING (E91)	12/04 > 12/12	BPW-128	ANTERIORE (FRONT)	34356764851 34356777650 34356789441	850 mm.
SERIE 3 TOURING (E91)	12/04 > 12/12	BPW-028	POSTERIORE (REAR)	34356762253 34356789445	1098 mm.
SERIE 3 TOURING (E91)	12/04 > 12/12	BPW-063	POSTERIORE (REAR)	34356792564	1107 mm.
SERIE 3 (G20 - G28 - G80) SERIE 3 TOURING (G21 - G81)	11/18 >	BPW-298	ANTERIORE (FRONT)	34356870354	795 mm.
SERIE 3 (G20 - G28 - G80) SERIE 3 TOURING (G21 - G81)	11/18 >	BPW-299	ANTERIORE (FRONT)	34356870349	760 mm.
SERIE 4 COUPE' (G22 - G26 - G82) SERIE 4 CABRIO (G23 - G83)	07/20 >	BPW-298	ANTERIORE (FRONT)	34356870354	795 mm.

APPLICAZIONE (APPLICATION)	ANNO (YEAR)	CODICE (CODE)	LATO (SIDE)	O.E. (OR. NUMBER)	LUNGH. (LENGHT)
SERIE 4 COUPE' (G22 - G26 - G82) SERIE 4 CABRIO (G23 - G83)	07/20 >	BPW-299	ANTERIORE (FRONT)	34356870349	760 mm.
SERIE 5 (E28)	01/85 > 12/87	BPW-119	POSTERIORE (REAR)	34111152607 34351180782 34351179819	262 mm.
SERIE 5 (E34) SERIE 5 TOURING (E34)	06/87 > 12/95	BPW-178	ANTERIORE (FRONT)	34112225107 34351179820 34351180432	230 mm.
SERIE 5 (E39) SERIE 5 TOURING (E39)	09/95 > 05/04	BPW-085	ANTERIORE (FRONT)	34351163065 34352229018	830 mm.
SERIE 5 (E39) SERIE 5 TOURING (E39)	09/95 > 05/04	BPW-111	POSTERIORE (REAR)	34351163066	545 mm.
SERIE 5 TOURING (E39)	03/97 > 05/04	BPW-206	POSTERIORE (REAR)	34351163207	1100 mm.
SERIE 5 TOURING (E61)	03/04 > 12/10	BPW-117	POSTERIORE (REAR)	34356763667 34356776423 34356789494	883 mm.
SERIE 5 (F10)	06/09 > 10/16	BPW-013	ANTERIORE (FRONT)	34356791958	1087 mm.
SERIE 5 (F10)	06/09 > 10/16	BPW-016	POSTERIORE (REAR)	34356791962	915 mm.
SERIE 5 GRAN TURISMO (F07)	04/11 > 12/17	BPW-013	ANTERIORE (FRONT)	34356791958	1087 mm.
SERIE 5 GRAN TURISMO (F07)	04/11 > 12/17	BPW-108	POSTERIORE (REAR)	34356791961	1055 mm.
SERIE 5 TOURING (F11)	11/09 > 02/17	BPW-013	ANTERIORE (FRONT)	34356791958	1087 mm.
SERIE 5 TOURING (F11)	11/09 > 02/17	BPW-114	POSTERIORE (REAR)	34356791963	1110 mm.
SERIE 5 (G30 - F90)	09/16 > 06/23	BPW-022	ANTERIORE (FRONT)	34356861807 34356890788	920 mm.
SERIE 5 (G30 - F90)	09/16 > 06/23	BPW-026	POSTERIORE (REAR)	34356861808 34356890791	925 mm.
SERIE 5 (G30 - F90)	09/16 > 06/23	BPW-124	POSTERIORE (REAR)	34216890792 34216861809	850 mm.

APPLICAZIONE (APPLICATION)	ANNO (YEAR)	CODICE (CODE)	LATO (SIDE)	O.E. (OR. NUMBER)	LUNGH. (LENGHT)
SERIE 5 TOURING (G31)	07/17 >	BPW-022	ANTERIORE (FRONT)	34356861807 34356890788	920 mm.
SERIE 5 TOURING (G31)	07/17 >	BPW-026	POSTERIORE (REAR)	34356861808 34356890791	925 mm.
SERIE 5 TOURING (G31)	07/17 >	BPW-124	POSTERIORE (REAR)	34216890792 34216861809	850 mm.
SERIE 6 (E24)	09/79 > 08/87	BPW-119	POSTERIORE (REAR)	34111152607 34351180782 34351179819	262 mm.
SERIE 6 (E63) SERIE 6 CABRIO (E64)	09/03 > 08/10	BPW-043	ANTERIORE (FRONT)	34356764298 34356776421 34356789492	670 mm.
SERIE 6 (E63) SERIE 6 CABRIO (E64)	09/03 > 08/10	BPW-055	POSTERIORE (REAR)	34356764299 34356776422 34356789493	670 mm.
SERIE 6 CABRIO (F12)	09/11 > 06/18	BPW-013	ANTERIORE (FRONT)	34356791958	1087 mm.
SERIE 6 CABRIO (F12)	09/11 > 06/18	BPW-016	POSTERIORE (REAR)	34356791962	915 mm.
SERIE 6 COUPE' (F13) SERIE 6 GRAN COUPE' (F06)	09/11 > 10/18	BPW-013	ANTERIORE (FRONT)	34356791958	1087 mm.
SERIE 6 COUPE' (F13) SERIE 6 GRAN COUPE' (F06)	09/11 > 10/18	BPW-016	POSTERIORE (REAR)	34356791962	915 mm.
SERIE 6 GRAN TURISMO (G32)	06/17 >	BPW-022	ANTERIORE (FRONT)	34356861807 34356890788	920 mm.
SERIE 6 GRAN TURISMO (G32)	06/17 >	BPW-124	POSTERIORE (REAR)	34216890792 34216861809	850 mm.
SERIE 7 (E32)	03/87 > 09/94	BPW-178	ANTERIORE (FRONT)	34112225107 34351179820 34351180432	230 mm.
SERIE 7 (E38)	03/94 > 11/01	BPW-191	POSTERIORE (REAR)	34351182065	620 mm.
SERIE 7 (E65 - E66 - E67)	07/01 > 08/08	BPW-112	ANTERIORE (FRONT)	34356755266 34356778037	830 mm.
SERIE 7 (E65 - E66 - E67)	07/01 > 08/08	BPW-113	POSTERIORE (REAR)	34356755267 34356778038	845 mm.

N.B.: I CODICI O.E. ED IL LORO TESTO SONO RIPORTATI SOLO A TITOLO INDICATIVO
THE O.E. CODES AND THEIR TEXT ARE REPORTED ONLY FOR INDICATIVE PURPOSE

APPLICAZIONE (APPLICATION)	ANNO (YEAR)	CODICE (CODE)	LATO (SIDE)	O.E. (OR. NUMBER)	LUNGH. (LENGHT)
SERIE 7 (F01 - F02 - F03 - F04)	09/08 > 12/15	BPW-013	ANTERIORE (FRONT)	34356791958	1087 mm.
SERIE 7 (G11 - G12)	09/15 > 06/22	BPW-022	ANTERIORE (FRONT)	34356861807 34356890788	920 mm.
SERIE 7 (G11 - G12)	09/15 > 06/22	BPW-026	POSTERIORE (REAR)	34356861808 34356890791	925 mm.
SERIE 7 (F01 - F02 - F03 - F04)	09/08 > 12/15	BPW-082	POSTERIORE (REAR)	34356791960	1065 mm.
SERIE 8 (E31)	01/90 > 08/94	BPW-178	ANTERIORE (FRONT)	34112225107 34351179820 34351180432	230 mm.
SERIE 8 CABRIO (G14 - F91)	07/18 >	BPW-022	ANTERIORE (FRONT)	34356861807 34356890788	920 mm.
SERIE 8 CABRIO (G14 - F91)	07/18 >	BPW-026	POSTERIORE (REAR)	34356861808 34356890791	925 mm.
SERIE 8 COUPE' (G15 - F92) SERIE 8 GRAN COUPE' (G16 - F93)	07/18 >	BPW-022	ANTERIORE (FRONT)	34356861807 34356890788	920 mm.
SERIE 8 COUPE' (G15 - F92) SERIE 8 GRAN COUPE' (G16 - F93)	07/18 >	BPW-026	POSTERIORE (REAR)	34356861808 34356890791	925 mm.
X1 (E84)	09/09 > 06/15	BPW-062	ANTERIORE (FRONT)	34356792561	867 mm.
X1 (E84)	09/09 > 06/15	BPW-079	ANTERIORE (FRONT)	34356792562	676 mm.
X1 (E84)	09/09 > 06/15	BPW-128	ANTERIORE (FRONT)	34356764851 34356777650 34356789441	850 mm.
X1 (E84)	09/09 > 06/15	BPW-205	ANTERIORE (FRONT)	34356790340	632 mm.
X1 (E84)	09/09 > 06/15	BPW-056	POSTERIORE (REAR)	34356792565	1141 mm.
X1 (E84)	09/09 > 06/15	BPW-144	POSTERIORE (REAR)	34356790341	1120 mm.
X1 (F48)	11/14 > 06/22	BPW-015	ANTERIORE (FRONT)	34356888167 34356865613 34351543830	655 mm.

APPLICAZIONE (APPLICATION)	ANNO (YEAR)	CODICE (CODE)	LATO (SIDE)	O.E. (OR. NUMBER)	LUNGH. (LENGHT)
X1 (F48)	11/14 > 06/22	BPW-011	POSTERIORE (REAR)	34356865612 34356799736	655 mm.
X2 (F39)	11/17 > 10/23	BPW-015	ANTERIORE (FRONT)	34356888167 34356865613 34351543830	655 mm.
X2 (F39)	11/17 > 10/23	BPW-011	POSTERIORE (REAR)	34356865612 34356799736	655 mm.
X3 (E83)	01/04 > 08/10	BPW-081	ANTERIORE (FRONT)	34353411756	740 mm.
X3 (E83)	01/04 > 08/10	BPW-084	POSTERIORE (REAR)	34353411757	1055 mm.
X3 (F25)	09/10 > 08/17	BPW-029	ANTERIORE (FRONT)	34356790303	955 mm.
X3 (F25)	09/10 > 08/17	BPW-030	POSTERIORE (REAR)	34356790304	1234 mm.
X3 (G01 - F97 - G08)	08/17 >	BPW-049	ANTERIORE (FRONT)	34356870351	770 mm.
X3 (G01 - F97 - G08)	08/17 >	BPW-053	POSTERIORE (REAR)	34356870350	740 mm.
X4 (F26)	04/14 > 03/18	BPW-029	ANTERIORE (FRONT)	34356790303	955 mm.
X4 (F26)	04/14 > 03/18	BPW-030	POSTERIORE (REAR)	34356790304	1234 mm.
X4 (G02 - F98)	04/18 >	BPW-049	ANTERIORE (FRONT)	34356870351	770 mm.
X4 (G02 - F98)	04/18 >	BPW-053	POSTERIORE (REAR)	34356870350	740 mm.
X4 (G02 - F98)	04/18 >	BPW-102	POSTERIORE (REAR)	34356880543	750 mm.
X5 (E53)	04/00 > 10/06	BPW-078	ANTERIORE (FRONT)	34351165579	800 mm.
X5 (E53)	04/00 > 10/06	BPW-071	POSTERIORE (REAR)	34351165580	715 mm.

APPLICAZIONE (APPLICATION)	ANNO (YEAR)	CODICE (CODE)	LATO (SIDE)	O.E. (OR. NUMBER)	LUNGH. (LENGHT)
X5 (E70)	10/08 > 07/13	BPW-038	ANTERIORE (FRONT)	34356792567	895 mm.
X5 (E70)	10/08 > 07/13	BPW-060	ANTERIORE (FRONT)	34356772008 34356789501	970 mm.
X5 (E70)	10/08 > 07/13	BPW-158	ANTERIORE (FRONT)	34356773008 34356789502	960 mm.
X5 (E70)	10/08 > 07/13	BPW-044	POSTERIORE (REAR)	34356792571 34356854168	1050 mm.
X5 (E70)	10/08 > 07/13	BPW-058	POSTERIORE (REAR)	34356771766 34356780699 34356789505	1006 mm.
X5 (F15 - F85)	12/13 > 07/18	BPW-038	ANTERIORE (FRONT)	34356792567	895 mm.
X5 (F15 - F85)	12/13 > 07/18	BPW-134	ANTERIORE (FRONT)	34356792568	1020 mm.
X5 (F15 - F85)	12/13 > 07/18	BPW-044	POSTERIORE (REAR)	34356792571 34356854168	1050 mm.
X5 (G05 - F95)	08/18 > 03/23	BPW-057	ANTERIORE (FRONT)	34356870353	850 mm.
X5 (G05 - F95)	08/18 > 03/23	BPW-074	POSTERIORE (REAR)	34356870352	755 mm.
X6 (E71 - E72)	01/08 > 07/14	BPW-038	ANTERIORE (FRONT)	34356792567	895 mm.
X6 (E71 - E72)	01/08 > 07/14	BPW-060	ANTERIORE (FRONT)	34356772008 34356789501	970 mm.
X6 (E71 - E72)	01/08 > 07/14	BPW-134	ANTERIORE (FRONT)	34356792568	1020 mm.
X6 (E71 - E72)	01/08 > 07/14	BPW-158	ANTERIORE (FRONT)	34356773008 34356789502	960 mm.
X6 (E71 - E72)	01/08 > 07/14	BPW-044	POSTERIORE (REAR)	34356792571 34356854168	1050 mm.
X6 (E71 - E72)	01/08 > 07/14	BPW-058	POSTERIORE (REAR)	34356771766 34356780699 34356789505	1006 mm.

N.B.: I CODICI O.E. ED IL LORO TESTO SONO RIPORTATI SOLO A TITOLO INDICATIVO
THE O.E. CODES AND THEIR TEXT ARE REPORTED ONLY FOR INDICATIVE PURPOSE

APPLICAZIONE (APPLICATION)	ANNO (YEAR)	CODICE (CODE)	LATO (SIDE)	O.E. (OR. NUMBER)	LUNGH. (LENGHT)
X6 (F16 - F86)	08/14 > 07/19	BPW-038	ANTERIORE (FRONT)	34356792567	895 mm.
X6 (F16 - F86)	08/14 > 07/19	BPW-134	ANTERIORE (FRONT)	34356792568	1020 mm.
X6 (F16 - F86)	08/14 > 07/19	BPW-044	POSTERIORE (REAR)	34356792571 34356854168	1050 mm.
X6 (G06 - F96)	08/19 > 03/23	BPW-057	ANTERIORE (FRONT)	34356870353	850 mm.
X6 (G06 - F96)	08/19 > 03/23	BPW-074	POSTERIORE (REAR)	34356870352	755 mm.
X7 (G07)	03/19 >	BPW-057	ANTERIORE (FRONT)	34356870353	850 mm.
X7 (G07)	03/19 >	BPW-074	POSTERIORE (REAR)	34356870352	755 mm.
Z1 ROADSTER	06/88 > 06/91	BPW-217	ANTERIORE (FRONT)	34351153964 34359058889	235 mm.
Z1 ROADSTER	06/88 > 06/91	BPW-119	POSTERIORE (REAR)	34111152607 34351180782 34351179819	262 mm.
Z3 (E36)	10/95 > 06/03	BPW-126	ANT. - POST. (FRONT - REAR)	34351181337 34351181338	776 mm.
Z4 ROADSTER (E85)	12/02 > 02/09	BPW-039	ANTERIORE (FRONT)	34351164371	596 mm.
Z4 ROADSTER (E86) Z4 COUPE' (E86)	04/06 > 08/08	BPW-227	POSTERIORE (REAR)	34356757896	1220 mm.
Z4 ROADSTER (E89)	02/09 > 08/16	BPW-198	ANTERIORE (FRONT)	34356792563	1015 mm.
Z4 ROADSTER (E89)	02/09 > 08/16	BPW-181	POSTERIORE (REAR)	34356792566	1361 mm.
Z4 ROADSTER (E89)	02/09 > 08/16	BPW-232	POSTERIORE (REAR)	34356789446	1338 mm.
Z4 ROADSTER (G29)	11/18 >	BPW-138	ANTERIORE (FRONT)	34356877085	710 mm.

APPLICAZIONE (APPLICATION)	ANNO (YEAR)	CODICE (CODE)	LATO (SIDE)	O.E. (OR. NUMBER)	LUNGH. (LENGHT)
DAILY II	01/89 > 05/99	BPW-288	ANTERIORE (FRONT)	42548208 42567357 500054528	300 mm.
DAILY II	01/89 > 05/99	BPW-294	ANTERIORE (FRONT)	1908825 1907942	495 mm.
DAILY III	05/99 > 07/07	BPW-288	ANTERIORE (FRONT)	42548208 42567357 500054528	300 mm.
DAILY III	09/04 > 04/06	BPW-289	ANTERIORE (FRONT)	42548195 42560913 500054692	210 mm.
DAILY III	05/99 > 07/07	BPW-290	POSTERIORE (REAR)	42548196 42559616 500054696	250 mm.
DAILY IV	05/06 > 08/11	BPW-285	ANT. - POST. (FRONT - REAR)	42555634 42560068 42567356	130 mm.
DAILY IV	05/06 > 08/11	BPW-286	POSTERIORE (REAR)	42548209 42556205 500054695	295 mm.
DAILY IV	05/06 > 08/11	BPW-311	POSTERIORE (REAR)	42548209 42556205 500054695	295 mm.
DAILY IV	05/06 > 08/11	BPW-290	POSTERIORE (REAR)	42548196 42559616 500054696	250 mm.
DAILY V	09/11 > 02/14	BPW-285	ANT. - POST. (FRONT - REAR)	42555634 42560068 42567356	130 mm.
DAILY V	09/11 > 02/14	BPW-311	POSTERIORE (REAR)	42548209 42556205 500054695	295 mm.
DAILY VI	04/16 >	BPW-311	POSTERIORE (REAR)	42548209 42556205 500054695	295 mm.

APPLICAZIONE (APPLICATION)	ANNO (YEAR)	CODICE (CODE)	LATO (SIDE)	O.E. (OR. NUMBER)	LUNGH. (LENGHT)
E-PACE (X540)	09/17 >	BPW-100	ANTERIORE (FRONT)	J9C2212	1145 mm.
E-PACE (X540)	09/17 >	BPW-105	ANTERIORE (FRONT)	J9C18499	1040 mm.
E-PACE (X540)	09/17 >	BPW-139	ANTERIORE (FRONT)	J9C2211	1115 mm.
E-PACE (X540)	09/17 >	BPW-165	ANTERIORE (FRONT)	J9C18500	1035 mm.
E-PACE (X540)	09/17 >	BPW-091	POSTERIORE (REAR)	J9C2076	940 mm.
F-PACE (X761)	09/15 >	BPW-130	POSTERIORE (REAR)	T4A3216	1015 mm.
F-TYPE CABRIO (X152)	10/12 >	BPW-305	ANTERIORE (FRONT)	C2P17004	590 mm.
I-PACE (X590)	02/18 >	BPW-308	POSTERIORE (REAR)	T4K4054	955 mm.
XE (X760)	03/15 >	BPW-073	POSTERIORE (REAR)	T2H2091	935 mm.
XF I (X250)	03/08 > 04/15	BPW-179	ANTERIORE (FRONT)	C2Z16061	610 mm.
XF I (X250)	03/08 > 04/15	BPW-305	ANTERIORE (FRONT)	C2P17004	590 mm.
XF II (X260)	05/15 >	BPW-073	POSTERIORE (REAR)	T2H2091	935 mm.
XF SPORTBRAKE (X250)	09/12 > 04/14	BPW-179	ANTERIORE (FRONT)	C2Z16061	610 mm.
XF SPORTBRAKE (X250)	09/12 > 04/14	BPW-305	ANTERIORE (FRONT)	C2P17004	590 mm.
XF SPORTBRAKE (X260)	07/17 >	BPW-073	POSTERIORE (REAR)	T2H2091	935 mm.
XJ (X351)	10/09 > 12/19	BPW-305	ANTERIORE (FRONT)	C2P17004	590 mm.

N.B.: I CODICI O.E. ED IL LORO TESTO SONO RIPORTATI SOLO A TITOLO INDICATIVO
THE O.E. CODES AND THEIR TEXT ARE REPORTED ONLY FOR INDICATIVE PURPOSE

APPLICAZIONE (APPLICATION)	ANNO (YEAR)	CODICE (CODE)	LATO (SIDE)	O.E. (OR. NUMBER)	LUNGH. (LENGHT)
DEFENDER S.W. (L663)	09/19 >	BPW-095	ANTERIORE (FRONT)	LR084048 LR122455	1295 mm.
DEFENDER S.W. (L663)	09/19 >	BPW-106	ANTERIORE (FRONT)	LR098988	1285 mm.
DEFENDER S.W. (L663)	09/19 >	BPW-087	POSTERIORE (REAR)	LR084071	940 mm.
DISCOVERY III (L319)	07/04 > 09/09	BPW-143	ANTERIORE (FRONT)	SEM500070	1184 mm.
DISCOVERY III (L319)	07/04 > 09/09	BPW-047	POSTERIORE (REAR)	SOE000024 SOE000025	1180 mm.
DISCOVERY IV (L319)	09/09 > 12/18	BPW-143	ANTERIORE (FRONT)	SEM500070	1184 mm.
DISCOVERY IV (L319)	09/09 > 12/18	BPW-047	POSTERIORE (REAR)	SOE000024 SOE000025	1180 mm.
DISCOVERY V (L462)	09/16 >	BPW-035	ANTERIORE (FRONT)	LR045959	1370 mm.
DISCOVERY V (L462)	09/16 >	BPW-095	ANTERIORE (FRONT)	LR084048 LR122455	1295 mm.
DISCOVERY V (L462)	09/16 >	BPW-106	ANTERIORE (FRONT)	LR098988	1285 mm.
DISCOVERY V (L462)	09/16 >	BPW-032	POSTERIORE (REAR)	LR033295	951 mm.
DISCOVERY V (L462)	09/16 >	BPW-087	POSTERIORE (REAR)	LR084071	940 mm.
DISCOVERY SPORT (L550)	09/14 >	BPW-050	ANTERIORE (FRONT)	LR061365 LR121267	1170 mm.
DISCOVERY SPORT (L550)	09/14 >	BPW-105	ANTERIORE (FRONT)	LR115018	1040 mm.
DISCOVERY SPORT (L550)	09/14 >	BPW-135	ANTERIORE (FRONT)	LR083646	1185 mm.
DISCOVERY SPORT (L550)	09/14 >	BPW-070	POSTERIORE (REAR)	LR061394 LR072544	857 mm.

N.B.: I CODICI O.E. ED IL LORO TESTO SONO RIPORTATI SOLO A TITOLO INDICATIVO
THE O.E. CODES AND THEIR TEXT ARE REPORTED ONLY FOR INDICATIVE PURPOSE

APPLICAZIONE (APPLICATION)	ANNO (YEAR)	CODICE (CODE)	LATO (SIDE)	O.E. (OR. NUMBER)	LUNGH. (LENGHT)
DISCOVERY SPORT (L550)	09/14 >	BPW-091	POSTERIORE (REAR)	J9C2076	940 mm.
RANGE ROVER III (L322)	03/02 > 08/12	BPW-132	ANTERIORE (FRONT)	SEM000010 SEM000011 SEM000012	780 mm.
RANGE ROVER III (L322)	03/02 > 08/12	BPW-109	POSTERIORE (REAR)	SOE500030	1158 mm.
RANGE ROVER III (L322)	03/02 > 08/12	BPW-204	POSTERIORE (REAR)	SOE000010 SOE000011	1120 mm.
RANGE ROVER IV (L405)	08/12 > 09/21	BPW-035	ANTERIORE (FRONT)	LR045959	1370 mm.
RANGE ROVER IV (L405)	08/12 > 09/21	BPW-080	ANTERIORE (FRONT)	LR033275	1424 mm.
RANGE ROVER IV (L405)	08/12 > 09/21	BPW-095	ANTERIORE (FRONT)	LR084048 LR122455	1295 mm.
RANGE ROVER IV (L405)	08/12 > 09/21	BPW-106	ANTERIORE (FRONT)	LR098988	1285 mm.
RANGE ROVER IV (L405)	08/12 > 09/21	BPW-032	POSTERIORE (REAR)	LR033295	951 mm.
RANGE ROVER IV (L405)	10/17 > 09/21	BPW-087	POSTERIORE (REAR)	LR084071	940 mm.
RANGE ROVER V (L460)	10/21 >	BPW-304	ANTERIORE (FRONT)	LR153546	550 mm.
RANGE ROVER EVOQUE (L538)	05/11 > 12/19	BPW-050	ANTERIORE (FRONT)	LR061365 LR121267	1170 mm.
RANGE ROVER EVOQUE (L538)	05/11 > 12/19	BPW-135	ANTERIORE (FRONT)	LR083646	1185 mm.
RANGE ROVER EVOQUE (L551)	12/18 >	BPW-105	ANTERIORE (FRONT)	LR115018	1040 mm.
RANGE ROVER EVOQUE (L551)	12/18 >	BPW-165	ANTERIORE (FRONT)	LR115019	1035 mm.
RANGE ROVER EVOQUE (L551)	12/18 >	BPW-091	POSTERIORE (REAR)	J9C2076	940 mm.

N.B.: I CODICI O.E. ED IL LORO TESTO SONO RIPORTATI SOLO A TITOLO INDICATIVO
THE O.E. CODES AND THEIR TEXT ARE REPORTED ONLY FOR INDICATIVE PURPOSE

APPLICAZIONE (APPLICATION)	ANNO (YEAR)	CODICE (CODE)	LATO (SIDE)	O.E. (OR. NUMBER)	LUNGH. (LENGHT)
RANGE ROVER SPORT I (L320)	02/05 > 03/13	BPW-099	ANTERIORE (FRONT)	SEM500062	1230 mm.
RANGE ROVER SPORT I (L320)	02/05 > 03/13	BPW-186	ANTERIORE (FRONT)	SEM500026 SEM500090	1209 mm.
RANGE ROVER SPORT I (L320)	02/05 > 03/13	BPW-047	POSTERIORE (REAR)	SOE000024 SOE000025	1180 mm.
RANGE ROVER SPORT II (L494)	04/13 > 03/22	BPW-035	ANTERIORE (FRONT)	LR045959	1370 mm.
RANGE ROVER SPORT II (L494)	04/13 > 03/22	BPW-080	ANTERIORE (FRONT)	LR033275	1424 mm.
RANGE ROVER SPORT II (L494)	04/13 > 03/22	BPW-095	ANTERIORE (FRONT)	LR084048 LR122455	1295 mm.
RANGE ROVER SPORT II (L494)	04/13 > 03/22	BPW-106	ANTERIORE (FRONT)	LR098988	1285 mm.
RANGE ROVER SPORT II (L494)	04/13 > 03/22	BPW-032	POSTERIORE (REAR)	LR033295	951 mm.
RANGE ROVER SPORT II (L494)	10/17 > 03/22	BPW-087	POSTERIORE (REAR)	LR084071	940 mm.
RANGE ROVER SPORT III (L461)	04/22 >	BPW-304	ANTERIORE (FRONT)	LR153546	550 mm.
RANGE ROVER VELAR (L560)	03/17 >	BPW-130	POSTERIORE (REAR)	T4A3216	1015 mm.

N.B.: I CODICI O.E. ED IL LORO TESTO SONO RIPORTATI SOLO A TITOLO INDICATIVO
THE O.E. CODES AND THEIR TEXT ARE REPORTED ONLY FOR INDICATIVE PURPOSE

APPLICAZIONE (APPLICATION)	ANNO (YEAR)	CODICE (CODE)	LATO (SIDE)	O.E. (OR. NUMBER)	LUNGH. (LENGHT)
190 (W201)	10/82 > 08/93	BPW-054	ANTERIORE (FRONT)	A2015400317	150 mm.
200 (W124)	04/85 > 06/93	BPW-054	ANTERIORE (FRONT)	A2015400317	150 mm.
CLASSE A (W168)	07/97 > 08/04	BPW-025	ANT. - POST. (FRONT - REAR)	A0005400217 A1265402017 A1405401217	90 mm.
CLASSE A (W169)	09/04 > 06/12	BPW-003	ANT. - POST. (FRONT - REAR)	A2205400617 A2205400717	98 mm.
CLASSE A (W176)	06/12 > 05/18	BPW-005	ANTERIORE (FRONT)	A1695401617	93 mm.
CLASSE A (W177)	03/18 >	BPW-005	ANTERIORE (FRONT)	A1695401617	93 mm.
CLASSE B (W245)	03/05 > 11/11	BPW-003	ANT. - POST. (FRONT - REAR)	A2205400617 A2205400717	98 mm.
CLASSE B (W246)	11/11 > 12/18	BPW-005	ANTERIORE (FRONT)	A1695401617	93 mm.
CLASSE B (W247)	12/18 >	BPW-005	ANTERIORE (FRONT)	A1695401617	93 mm.
CLASSE C (W203)	05/00 > 02/07	BPW-003	ANT. - POST. (FRONT - REAR)	A2205400617 A2205400717	98 mm.
CLASSE C (W204)	01/07 > 03/14	BPW-003	ANT. - POST. (FRONT - REAR)	A2205400617 A2205400717	98 mm.
CLASSE C (W204)	01/07 > 03/14	BPW-295	ANTERIORE (FRONT)	A1715400617	117 mm.
CLASSE C (W205)	12/13 > 06/21	BPW-005	ANTERIORE (FRONT)	A1695401617	93 mm.
CLASSE C (W206)	03/21 >	BPW-005	ANTERIORE (FRONT)	A1695401617	93 mm.
CLASSE C (W206)	03/21 >	BPW-019	ANTERIORE (FRONT)	A2319050014	100 mm.
CLASSE CLC (CL203)	05/08 > 06/11	BPW-003	ANT. - POST. (FRONT - REAR)	A2205400617 A2205400717	98 mm.

APPLICAZIONE (APPLICATION)	ANNO (YEAR)	CODICE (CODE)	LATO (SIDE)	O.E. (OR. NUMBER)	LUNGH. (LENGHT)
190 (W201)	10/82 > 08/93	BPW-054	ANTERIORE (FRONT)	A2015400317	150 mm.
200 (W124)	04/85 > 06/93	BPW-054	ANTERIORE (FRONT)	A2015400317	150 mm.
CLASSE A (W168)	07/97 > 08/04	BPW-025	ANT. - POST. (FRONT - REAR)	A0005400217 A1265402017 A1405401217	90 mm.
CLASSE A (W169)	09/04 > 06/12	BPW-003	ANT. - POST. (FRONT - REAR)	A2205400617 A2205400717	98 mm.
CLASSE A (W176)	06/12 > 05/18	BPW-005	ANTERIORE (FRONT)	A1695401617	93 mm.
CLASSE A (W177)	03/18 >	BPW-005	ANTERIORE (FRONT)	A1695401617	93 mm.
CLASSE B (W245)	03/05 > 11/11	BPW-003	ANT. - POST. (FRONT - REAR)	A2205400617 A2205400717	98 mm.
CLASSE B (W246)	11/11 > 12/18	BPW-005	ANTERIORE (FRONT)	A1695401617	93 mm.
CLASSE B (W247)	12/18 >	BPW-005	ANTERIORE (FRONT)	A1695401617	93 mm.
CLASSE C (W203)	05/00 > 02/07	BPW-003	ANT. - POST. (FRONT - REAR)	A2205400617 A2205400717	98 mm.
CLASSE C (W204)	01/07 > 03/14	BPW-003	ANT. - POST. (FRONT - REAR)	A2205400617 A2205400717	98 mm.
CLASSE C (W204)	01/07 > 03/14	BPW-295	ANTERIORE (FRONT)	A1715400617	117 mm.
CLASSE C (W205)	12/13 > 06/21	BPW-005	ANTERIORE (FRONT)	A1695401617	93 mm.
CLASSE C (W206)	03/21 >	BPW-005	ANTERIORE (FRONT)	A1695401617	93 mm.
CLASSE C (W206)	03/21 >	BPW-019	ANTERIORE (FRONT)	A2319050014	100 mm.
CLASSE CLC (CL203)	05/08 > 06/11	BPW-003	ANT. - POST. (FRONT - REAR)	A2205400617 A2205400717	98 mm.

APPLICAZIONE (APPLICATION)	ANNO (YEAR)	CODICE (CODE)	LATO (SIDE)	O.E. (OR. NUMBER)	LUNGH. (LENGHT)
CLASSE E (W124)	06/93 > 03/98	BPW-054	ANTERIORE (FRONT)	A2015400317	150 mm.
CLASSE E (W210)	02/96 > 03/03	BPW-025	ANT. - POST. (FRONT - REAR)	A0005400217 A1265402017 A1405401217	90 mm.
CLASSE E (W211)	03/02 > 12/08	BPW-001	ANT. - POST. (FRONT - REAR)	A1645401017 A2205401517	95 mm.
CLASSE E (W211)	03/02 > 12/08	BPW-003	ANT. - POST. (FRONT - REAR)	A2205400617 A2205400717	98 mm.
CLASSE E (W211)	03/02 > 12/08	BPW-002	ANTERIORE (FRONT)	A2115400717	100 mm.
CLASSE E (W211)	03/02 > 12/08	BPW-295	ANTERIORE (FRONT)	A1715400617	117 mm.
CLASSE E (W212)	01/09 > 12/16	BPW-003	ANT. - POST. (FRONT - REAR)	A2205400617 A2205400717	98 mm.
CLASSE E (W212)	01/09 > 12/16	BPW-295	ANTERIORE (FRONT)	A1715400617	117 mm.
CLASSE E (W213)	01/17 > 10/23	BPW-005	ANTERIORE (FRONT)	A1695401617	93 mm.
CLASSE E (W213)	01/17 > 10/23	BPW-003	ANT. - POST. (FRONT - REAR)	A2205400617 A2205400717	98 mm.
CLASSE E (W213)	01/17 > 10/23	BPW-019	ANTERIORE (FRONT)	A2319050014	100 mm.
CLASSE E (W213)	01/17 > 10/23	BPW-295	ANTERIORE (FRONT)	A1715400617	117 mm.
CLASSE G (W463)	04/99 > 04/18	BPW-005	ANTERIORE (FRONT)	A1695401617	93 mm.
CLASSE G (W463)	04/99 > 04/18	BPW-001	ANT. - POST. (FRONT - REAR)	A1645401017 A2205401517	95 mm.
CLASSE G (W463)	04/99 > 04/18	BPW-003	ANT. - POST. (FRONT - REAR)	A2205400617 A2205400717	98 mm.
CLASSE G (W463)	08/96 > 12/15	BPW-012	ANT. - POST. (FRONT - REAR)	A9015400017 A9015400117	210 mm.

APPLICAZIONE (APPLICATION)	ANNO (YEAR)	CODICE (CODE)	LATO (SIDE)	O.E. (OR. NUMBER)	LUNGH. (LENGHT)
CLASSE G (W463)	08/96 > 12/15	BPW-012	ANT. - POST. (FRONT - REAR)	A9015400017 A9015400117	210 mm.
CLASSE G (W463)	08/96 > 12/15	BPW-154	ANT. - POST. (FRONT - REAR)	A2025400717	150 mm.
CLASSE G (W463)	08/96 > 12/15	BPW-295	ANTERIORE (FRONT)	A1715400617	117 mm.
CLASSE GL (X164)	09/06 > 12/12	BPW-001	ANT. - POST. (FRONT - REAR)	A1645401017 A2205401517	95 mm.
CLASSE GL (X166)	07/12 > 10/15	BPW-001	ANT. - POST. (FRONT - REAR)	A1645401017 A2205401517	95 mm.
CLASSE GL (X166)	07/12 > 10/15	BPW-003	ANT. - POST. (FRONT - REAR)	A2205400617 A2205400717	98 mm.
CLASSE GL (X166)	07/12 > 10/15	BPW-295	ANTERIORE (FRONT)	A1715400617	117 mm.
CLASSE GLA (X156)	12/13 > 12/19	BPW-005	ANTERIORE (FRONT)	A1695401617	93 mm.
CLASSE GLK (X204)	12/08 > 06/15	BPW-003	ANT. - POST. (FRONT - REAR)	A2205400617 A2205400717	98 mm.
CLASSE M (W163)	02/98 > 06/05	BPW-107	ANT. - POST. (FRONT - REAR)	A1635401517 A1635401717	112 mm.
CLASSE M (W163)	02/98 > 06/05	BPW-154	ANT. - POST. (FRONT - REAR)	A2025400717	150 mm.
CLASSE M (W164)	07/05 > 12/11	BPW-001	ANT. - POST. (FRONT - REAR)	A1645401017 A2205401517	95 mm.
CLASSE M (W166)	06/11 > 12/15	BPW-001	ANT. - POST. (FRONT - REAR)	A1645401017 A2205401517	95 mm.
CLASSE M (W166)	06/11 > 12/15	BPW-003	ANT. - POST. (FRONT - REAR)	A2205400617 A2205400717	98 mm.
CLASSE M (W166)	06/11 > 12/15	BPW-295	ANTERIORE (FRONT)	A1715400617	117 mm.
CLASSE R (W251)	07/05 > 12/14	BPW-001	ANT. - POST. (FRONT - REAR)	A1645401017 A2205401517	95 mm.

N.B.: I CODICI O.E. ED IL LORO TESTO SONO RIPORTATI SOLO A TITOLO INDICATIVO
THE O.E. CODES AND THEIR TEXT ARE REPORTED ONLY FOR INDICATIVE PURPOSE

APPLICAZIONE (APPLICATION)	ANNO (YEAR)	CODICE (CODE)	LATO (SIDE)	O.E. (OR. NUMBER)	LUNGH. (LENGHT)
CLASSE S (W220)	09/02 > 08/05	BPW-001	ANT. - POST. (FRONT - REAR)	A1645401017 A2205401517	95 mm.
CLASSE S (W220)	09/02 > 08/05	BPW-003	ANT. - POST. (FRONT - REAR)	A2205400617 A2205400717	98 mm.
CLASSE S (W220)	09/02 > 08/05	BPW-002	ANTERIORE (FRONT)	A2115400717	100 mm.
CLASSE S (W221)	10/05 > 12/13	BPW-003	ANT. - POST. (FRONT - REAR)	A2205400617 A2205400717	98 mm.
CLASSE S (W221)	10/05 > 12/13	BPW-295	ANTERIORE (FRONT)	A1715400617	117 mm.
CLASSE S (W222)	05/13 > 07/20	BPW-003	ANT. - POST. (FRONT - REAR)	A2205400617 A2205400717	98 mm.
CLASSE S (W222)	05/13 > 07/20	BPW-295	ANTERIORE (FRONT)	A1715400617	117 mm.
CLASSE S (W223)	09/20 > 06/23	BPW-005	ANTERIORE (FRONT)	A1695401617	93 mm.
CLASSE S (W223)	09/20 > 06/23	BPW-019	ANTERIORE (FRONT)	A2319050014	100 mm.
CLASSE V (W638/2)	09/96 > 07/03	BPW-012	ANT. - POST. (FRONT - REAR)	A9015400017 A9015400117	210 mm.
CLASSE V (W638/2)	09/96 > 07/03	BPW-061	ANT. - POST. (FRONT - REAR)	A9015400217 A9015400317	190 mm.
CLASSE V (W447)	03/14 >	BPW-004	ANT. - POST. (FRONT - REAR)	A9065401417 A9065401517	105 mm.
CLA (C117)	01/13 > 13/19	BPW-005	ANTERIORE (FRONT)	A1695401617	93 mm.
CLA (C118)	03/19 >	BPW-005	ANTERIORE (FRONT)	A1695401617	93 mm.
CLK (C209)	06/02 > 03/10	BPW-003	ANT. - POST. (FRONT - REAR)	A2205400617 A2205400717	98 mm.
CLK (C209)	06/02 > 03/10	BPW-002	ANTERIORE (FRONT)	A2115400717	100 mm.

N.B.: I CODICI O.E. ED IL LORO TESTO SONO RIPORTATI SOLO A TITOLO INDICATIVO
THE O.E. CODES AND THEIR TEXT ARE REPORTED ONLY FOR INDICATIVE PURPOSE

APPLICAZIONE (APPLICATION)	ANNO (YEAR)	CODICE (CODE)	LATO (SIDE)	O.E. (OR. NUMBER)	LUNGH. (LENGHT)
CLK (C209)	06/02 > 03/10	BPW-295	ANTERIORE (FRONT)	A1715400617	117 mm.
CLS (C218)	01/11 > 12/17	BPW-003	ANT. - POST. (FRONT - REAR)	A2205400617 A2205400717	98 mm.
CLS (C218)	01/11 > 12/17	BPW-295	ANTERIORE (FRONT)	A1715400617	117 mm.
CLS (C257)	12/17 >	BPW-005	ANTERIORE (FRONT)	A1695401617	93 mm.
CLS (C219)	10/04 > 12/10	BPW-003	ANT. - POST. (FRONT - REAR)	A2205400617 A2205400717	98 mm.
CLS (C219)	10/04 > 12/10	BPW-002	ANTERIORE (FRONT)	A2115400717	100 mm.
CLS (C219)	10/04 > 12/10	BPW-019	ANTERIORE (FRONT)	A2319050014	100 mm.
CLS (C219)	10/04 > 12/10	BPW-295	ANTERIORE (FRONT)	A1715400617	117 mm.
EQA - EQB - EQC - EQE - EQS	02/21 >	BPW-005	ANTERIORE (FRONT)	A1695401617	93 mm.
EQV (W447)	11/21 >	BPW-004	ANT. - POST. (FRONT - REAR)	A9065401417 A9065401517	105 mm.
GLA (H247)	02/20 >	BPW-005	ANTERIORE (FRONT)	A1695401617	93 mm.
GLB (X247)	08/19 >	BPW-005	ANTERIORE (FRONT)	A1695401617	93 mm.
GLC (X253)	06/15 > 06/22	BPW-005	ANTERIORE (FRONT)	A1695401617	93 mm.
GLC (X253)	06/15 > 06/22	BPW-295	ANTERIORE (FRONT)	A1715400617	117 mm.
GLC (X254)	06/22 >	BPW-005	ANTERIORE (FRONT)	A1695401617	93 mm.
GLC COUPE' (C253)	06/16 > 03/23	BPW-005	ANTERIORE (FRONT)	A1695401617	93 mm.

N.B.: I CODICI O.E. ED IL LORO TESTO SONO RIPORTATI SOLO A TITOLO INDICATIVO
THE O.E. CODES AND THEIR TEXT ARE REPORTED ONLY FOR INDICATIVE PURPOSE

APPLICAZIONE (APPLICATION)	ANNO (YEAR)	CODICE (CODE)	LATO (SIDE)	O.E. (OR. NUMBER)	LUNGH. (LENGHT)
GLC COUPE' (C253)	06/16 > 03/23	BPW-295	ANTERIORE (FRONT)	A1715400617	117 mm.
GLE (W166)	04/15 > 10/18	BPW-001	ANT. - POST. (FRONT - REAR)	A1645401017 A2205401517	95 mm.
GLE (W166)	04/15 > 10/18	BPW-003	ANT. - POST. (FRONT - REAR)	A2205400617 A2205400717	98 mm.
GLE (W166)	04/15 > 10/18	BPW-295	ANTERIORE (FRONT)	A1715400617	117 mm.
GLE (V167)	10/18 >	BPW-005	ANTERIORE (FRONT)	A1695401617	93 mm.
GLE (V167)	10/18 >	BPW-295	ANTERIORE (FRONT)	A1715400617	117 mm.
GLE COUPE' (C292)	03/15 > 10/19	BPW-001	ANT. - POST. (FRONT - REAR)	A1645401017 A2205401517	95 mm.
GLE COUPE' (C292)	03/15 > 10/19	BPW-003	ANT. - POST. (FRONT - REAR)	A2205400617 A2205400717	98 mm.
GLE COUPE' (C167)	11/19 >	BPW-005	ANTERIORE (FRONT)	A1695401617	93 mm.
GLS (X166)	11/15 > 04/19	BPW-001	ANT. - POST. (FRONT - REAR)	A1645401017 A2205401517	95 mm.
GLS (X166)	11/15 > 04/19	BPW-003	ANT. - POST. (FRONT - REAR)	A2205400617 A2205400717	98 mm.
GLS (X166)	11/15 > 04/19	BPW-295	ANTERIORE (FRONT)	A1715400617	117 mm.
GLS (X167)	04/19 >	BPW-005	ANTERIORE (FRONT)	A1695401617	93 mm.
GLS (X167)	04/19 >	BPW-295	ANTERIORE (FRONT)	A1715400617	117 mm.
SL (R230)	10/01 > 01/12	BPW-003	ANT. - POST. (FRONT - REAR)	A2205400617 A2205400717	98 mm.
SL (R230)	10/01 > 01/12	BPW-295	ANTERIORE (FRONT)	A1715400617	117 mm.

N.B.: I CODICI O.E. ED IL LORO TESTO SONO RIPORTATI SOLO A TITOLO INDICATIVO
THE O.E. CODES AND THEIR TEXT ARE REPORTED ONLY FOR INDICATIVE PURPOSE

APPLICAZIONE (APPLICATION)	ANNO (YEAR)	CODICE (CODE)	LATO (SIDE)	O.E. (OR. NUMBER)	LUNGH. (LENGHT)
SL (R231)	02/12 > 04/20	BPW-003	ANT. - POST. (FRONT - REAR)	A2205400617 A2205400717	98 mm.
SL (R231)	02/12 > 04/20	BPW-019	ANTERIORE (FRONT)	A2319050014	100 mm.
SL (R231)	02/12 > 04/20	BPW-295	ANTERIORE (FRONT)	A1715400617	117 mm.
SL (R232)	03/22 >	BPW-005	ANTERIORE (FRONT)	A1695401617	93 mm.
SLC (R172)	01/16 >	BPW-003	ANT. - POST. (FRONT - REAR)	A2205400617 A2205400717	98 mm.
SLK (R170)	03/00 > 04/04	BPW-025	ANT. - POST. (FRONT - REAR)	A0005400217 A1265402017 A1405401217	90 mm.
SLK (R171)	03/04 > 02/11	BPW-003	ANT. - POST. (FRONT - REAR)	A2205400617 A2205400717	98 mm.
SLK (R171)	03/04 > 02/11	BPW-002	ANTERIORE (FRONT)	A2115400717	100 mm.
SLK (R171)	03/04 > 02/11	BPW-295	ANTERIORE (FRONT)	A1715400617	117 mm.
SLK (R172)	02/11 >	BPW-003	ANT. - POST. (FRONT - REAR)	A2205400617 A2205400717	98 mm.
SPRINTER 2T (B901 - B902)	02/95 > 05/06	BPW-012	ANT. - POST. (FRONT - REAR)	A9015400017 A9015400117	210 mm.
SPRINTER 2T (B901 - B902)	02/95 > 05/06	BPW-061	ANT. - POST. (FRONT - REAR)	A9015400217 A9015400317	190 mm.
SPRINTER 3T (B903)	02/95 > 05/06	BPW-012	ANT. - POST. (FRONT - REAR)	A9015400017 A9015400117	210 mm.
SPRINTER 3T (B903)	02/95 > 05/06	BPW-061	ANT. - POST. (FRONT - REAR)	A9015400217 A9015400317	190 mm.
SPRINTER 3-T - 3,5-T (B906)	06/06 > 12/18	BPW-004	ANT. - POST. (FRONT - REAR)	A9065401417 A9065401517	105 mm.
SPRINTER 3-T - 3,5-T (B906 - B907 - B910)	06/06 > 12/18	BPW-007	ANT. - POST. (FRONT - REAR)	A9065401417 A9065401517	95 mm.

N.B.: I CODICI O.E. ED IL LORO TESTO SONO RIPORTATI SOLO A TITOLO INDICATIVO
THE O.E. CODES AND THEIR TEXT ARE REPORTED ONLY FOR INDICATIVE PURPOSE

APPLICAZIONE (APPLICATION)	ANNO (YEAR)	CODICE (CODE)	LATO (SIDE)	O.E. (OR. NUMBER)	LUNGH. (LENGHT)
SPRINTER 3-T - 3,5-T (B907 - 910)	02/18 > 12/23	BPW-004	ANT. - POST. (FRONT - REAR)	A9065401417 A9065401517	105 mm.
SPRINTER 4T (B904)	02/96 > 05/06	BPW-012	ANT. - POST. (FRONT - REAR)	A9015400017 A9015400117	210 mm.
SPRINTER 4T (B904)	02/96 > 05/06	BPW-061	ANT. - POST. (FRONT - REAR)	A9015400217 A9015400317	190 mm.
SPRINTER 4-T - 4,6-T (B906)	06/06 > 12/18	BPW-004	ANT. - POST. (FRONT - REAR)	A9065401417 A9065401517	105 mm.
SPRINTER 4-T - 4,6-T (B906 - B907 - B910)	06/06 > 12/18	BPW-007	ANT. - POST. (FRONT - REAR)	A9065401417 A9065401517	95 mm.
SPRINTER 4,6-T (B906)	03/09 > 12/18	BPW-018	POSTERIORE (REAR)	A9065401317	85 mm.
SPRINTER 5-T (B906)	06/06 > 12/16	BPW-004	ANT. - POST. (FRONT - REAR)	A9065401417 A9065401517	105 mm.
SPRINTER 5-T (B906)	06/06 > 12/16	BPW-007	ANT. - POST. (FRONT - REAR)	A9065401417 A9065401517	95 mm.
SPRINTER 5-T (B906)	06/06 > 12/16	BPW-018	POSTERIORE (REAR)	A9065401317	85 mm.
VANEO (414)	02/02 > 07/05	BPW-003	ANT. - POST. (FRONT - REAR)	A2205400617 A2205400717	98 mm.
VIANO (W639)	09/03 > 08/14	BPW-004	ANT. - POST. (FRONT - REAR)	A9065401417 A9065401517	105 mm.
VIANO (W639)	09/03 > 08/14	BPW-007	ANT. - POST. (FRONT - REAR)	A9065401417 A9065401517	95 mm.
VITO (W638)	02/96 > 07/03	BPW-012	ANT. - POST. (FRONT - REAR)	A9015400017 A9015400117	210 mm.
VITO (W638)	02/96 > 07/03	BPW-061	ANT. - POST. (FRONT - REAR)	A9015400217 A9015400317	190 mm.
VITO (W639)	09/03 > 08/14	BPW-004	ANT. - POST. (FRONT - REAR)	A9065401417 A9065401517	105 mm.
VITO (W639)	09/03 > 08/14	BPW-007	ANT. - POST. (FRONT - REAR)	A9065401417 A9065401517	95 mm.

N.B.: I CODICI O.E. ED IL LORO TESTO SONO RIPORTATI SOLO A TITOLO INDICATIVO
THE O.E. CODES AND THEIR TEXT ARE REPORTED ONLY FOR INDICATIVE PURPOSE

APPLICAZIONE (APPLICATION)	ANNO (YEAR)	CODICE (CODE)	LATO (SIDE)	O.E. (OR. NUMBER)	LUNGH. (LENGHT)
MINI (R50 - R53) MINI CABRIO (R52)	06/01 > 11/07	BPW-096	ANTERIORE (FRONT)	34356761447 34356778175	885 mm.
MINI (R50 - R53) MINI CABRIO (R52)	06/01 > 11/07	BPW-090	POSTERIORE (REAR)	34356761448	1095 mm.
MINI (R56) MINI CABRIO (R57)	10/06 > 06/15	BPW-067	ANTERIORE (FRONT)	34356792572	800 mm.
MINI (R56) MINI CABRIO (R57)	10/06 > 06/15	BPW-086	ANTERIORE (FRONT)	34356773017 34356783230 34356789329	802 mm.
MINI (R56) MINI CABRIO (R57)	10/06 > 06/15	BPW-059	POSTERIORE (REAR)	34356792573	1128 mm.
MINI (R56 - R57) (C./SENSORE CURVO)	10/06 > 06/15	BPW-077	POSTERIORE (REAR)	34356773018 34356783772 34356789330	1127 mm.
MINI COUPE' (R58) MINI ROADSTER (R59)	12/10 > 05/15	BPW-067	ANTERIORE (FRONT)	34356792572	800 mm.
MINI COUPE' (R58) MINI ROADSTER (R59)	12/10 > 05/15	BPW-059	POSTERIORE (REAR)	34356792573	1128 mm.
MINI (F55)	09/13 >	BPW-034	ANTERIORE (FRONT)	34356799735 34356887151 34356887827	435 mm.
MINI (F55)	09/13 >	BPW-011	POSTERIORE (REAR)	34356865612 34356799736	655 mm.
MINI (F56)	12/13 >	BPW-034	ANTERIORE (FRONT)	34356799735 34356887151 34356887827	435 mm.
MINI (F56)	12/13 >	BPW-011	POSTERIORE (REAR)	34356865612 34356799736	655 mm.
MINI COOPER (F56)	12/13 >	BPW-015	ANTERIORE (FRONT)	34356888167 34356865613 34351543830	655 mm.
MINI CABRIO (F57)	11/14 >	BPW-034	ANTERIORE (FRONT)	34356799735 34356887151 34356887827	435 mm.
MINI CABRIO (F57)	11/14 >	BPW-011	POSTERIORE (REAR)	34356865612 34356799736	655 mm.
MINI CLUBMAN (R55)	08/07 > 14	BPW-086	ANTERIORE (FRONT)	34356773017 34356783230 34356789329	802 mm.

N.B.: I CODICI O.E. ED IL LORO TESTO SONO RIPORTATI SOLO A TITOLO INDICATIVO
THE O.E. CODES AND THEIR TEXT ARE REPORTED ONLY FOR INDICATIVE PURPOSE

APPLICAZIONE (APPLICATION)	ANNO (YEAR)	CODICE (CODE)	LATO (SIDE)	O.E. (OR. NUMBER)	LUNGH. (LENGHT)
MINI CLUBMAN (R55)	08/07 > 14	BPW-059	POSTERIORE (REAR)	34356792573	1128 mm.
MINI CLUBMAN (R55) (C./SENSORE CURVO)	08/07 > 14	BPW-077	POSTERIORE (REAR)	34356773018 34356783772 34356789330	1127 mm.
MINI CLUBMAN (F54)	12/14 >	BPW-015	ANTERIORE (FRONT)	34356888167 34356865613 34351543830	655 mm.
MINI CLUBMAN (F54)	12/14 >	BPW-011	POSTERIORE (REAR)	34356865612 34356799736	655 mm.
MINI COUNTRYMAN (R60)	08/10 > 10/16	BPW-068	ANTERIORE (FRONT)	34359804833	910 mm.
MINI COUNTRYMAN (R60)	08/10 > 10/16	BPW-065	POSTERIORE (REAR)	34359804834	950 mm.
MINI COUNTRYMAN (F60)	10/16 >	BPW-034	ANTERIORE (FRONT)	34356799735 34356887151 34356887827	435 mm.
MINI COUNTRYMAN (F60)	10/16 >	BPW-011	POSTERIORE (REAR)	34356865612 34356799736	655 mm.
MINI COUNTRYMAN COOPER (F60)	10/16 >	BPW-015	ANTERIORE (FRONT)	34356888167 34356865613 34351543830	655 mm.
MINI PACEMAN (R61)	03/12 > 10/16	BPW-068	ANTERIORE (FRONT)	34359804833	910 mm.
MINI PACEMAN (R61)	03/12 > 10/16	BPW-065	POSTERIORE (REAR)	34359804834	950 mm.

APPLICAZIONE (APPLICATION)	ANNO (YEAR)	CODICE (CODE)	LATO (SIDE)	O.E. (OR. NUMBER)	LUNGH. (LENGHT)
ASCONA C	09/81 > 08/88	BPW-302	ANTERIORE (FRONT)	1238353	955 mm.
ASTRA F (T.T.)	09/91 > 09/98	BPW-252	ANTERIORE (FRONT)	90335784	670 mm.
ASTRA F (T.T.)	09/91 > 09/98	BPW-292	ANTERIORE (FRONT)	1238984 6238399	685 mm.
ASTRA G (T.T.)	02/98 > 10/05	BPW-162	ANTERIORE (FRONT)	1238442 6238075	720 mm.
ASTRA G (T.T.)	02/98 > 10/05	BPW-246	ANTERIORE (FRONT)	6235674	770 mm.
ASTRA H (T.T.)	03/04 > 10/10	BPW-141	ANTERIORE (FRONT)	6235647	290 mm.
CALIBRA A	08/89 > 07/97	BPW-252	ANTERIORE (FRONT)	90335784	670 mm.
CALIBRA A	08/89 > 07/97	BPW-292	ANTERIORE (FRONT)	1238984 6238399	685 mm.
KADETT D - E	08/79 > 02/93	BPW-302	ANTERIORE (FRONT)	1238353	955 mm.
MANTA B	08/77 > 08/88	BPW-302	ANTERIORE (FRONT)	1238353	955 mm.
OMEGA A (T.T.)	09/86 > 03/94	BPW-302	ANTERIORE (FRONT)	1238353	955 mm.
OMEGA B (T.T.)	03/94 > 07/03	BPW-175	ANTERIORE (FRONT)	6238323	730 mm.
OMEGA B (T.T.)	03/94 > 07/03	BPW-307	ANTERIORE (FRONT)	6238322	730 mm.
REKORD E S.W.	11/82 > 08/86	BPW-302	ANTERIORE (FRONT)	1238353	955 mm.
SIGNUM	05/03 > 12/08	BPW-141	ANTERIORE (FRONT)	6235647	290 mm.
SIGNUM	05/03 > 12/08	BPW-226	ANTERIORE (FRONT)	6238230	685 mm.

N.B.: I CODICI O.E. ED IL LORO TESTO SONO RIPORTATI SOLO A TITOLO INDICATIVO
THE O.E. CODES AND THEIR TEXT ARE REPORTED ONLY FOR INDICATIVE PURPOSE

APPLICAZIONE (APPLICATION)	ANNO (YEAR)	CODICE (CODE)	LATO (SIDE)	O.E. (OR. NUMBER)	LUNGH. (LENGHT)
VECTRA A (T.T.)	09/88 > 11/95	BPW-252	ANTERIORE (FRONT)	90335784	670 mm.
VECTRA A (T.T.)	09/88 > 11/95	BPW-292	ANTERIORE (FRONT)	1238984 6238399	685 mm.
VECTRA A (T.T.)	09/88 > 11/95	BPW-301	ANTERIORE (FRONT)	1238349 1238408	660 mm.
VECTRA B (T.T.)	10/95 > 07/03	BPW-180	ANTERIORE (FRONT)	90497051	660 mm.
VECTRA B (T.T.)	10/95 > 07/03	BPW-293	ANTERIORE (FRONT)	6238389	660 mm.
VECTRA C (T.T.)	04/02 > 01/09	BPW-141	ANTERIORE (FRONT)	6235647	290 mm.
VECTRA C (T.T.)	04/02 > 01/09	BPW-226	ANTERIORE (FRONT)	6238230	685 mm.
ZAFIRA A (T.T.)	04/99 > 06/05	BPW-162	ANTERIORE (FRONT)	1238442 6238075	720 mm.
ZAFIRA A (T.T.)	04/99 > 06/05	BPW-246	ANTERIORE (FRONT)	6235674	770 mm.
ZAFIRA B (T.T.)	07/05 > 04/15	BPW-141	ANTERIORE (FRONT)	6235647	290 mm.

N.B.: I CODICI O.E. ED IL LORO TESTO SONO RIPORTATI SOLO A TITOLO INDICATIVO
THE O.E. CODES AND THEIR TEXT ARE REPORTED ONLY FOR INDICATIVE PURPOSE

APPLICAZIONE (APPLICATION)	ANNO (YEAR)	CODICE (CODE)	LATO (SIDE)	O.E. (OR. NUMBER)	LUNGH. (LENGHT)
911 (996)	08/97 > 09/05	BPW-177	ANTERIORE (FRONT)	99661236500	440 mm.
911 (997)	07/04 > 12/08	BPW-177	ANTERIORE (FRONT)	99661236500	440 mm.
911 (997)	07/04 > 12/08	BPW-265	ANTERIORE (FRONT)	99761267800	390 mm.
BOXER (986)	09/96 > 12/04	BPW-177	ANTERIORE (FRONT)	99661236500	440 mm.
BOXER (986 - 987)	09/96 > 12/09	BPW-164	ANTERIORE (FRONT)	98661236500	440 mm.
CAYENNE (9PA)	09/02 > 09/10	BPW-014	ANTERIORE (FRONT)	95561236500	420 mm.
CAYENNE (9PA)	09/02 > 09/10	BPW-021	POSTERIORE (REAR)	95561236520 95561236530	255 mm.
CAYENNE (92A)	06/10 >	BPW-042	ANTERIORE (FRONT)	95861236500	296 mm.
CAYENNE (92A)	06/10 >	BPW-193	ANTERIORE (FRONT)	95561236560	375 mm.
CAYENNE (92A)	06/10 >	BPW-027	POSTERIORE (REAR)	95861236550	140 mm.
CAYMAN (987)	11/05 > 12/12	BPW-164	ANTERIORE (FRONT)	98661236500	440 mm.
MACAN (95B)	02/14 >	BPW-092	ANTERIORE (FRONT)	95B907253A	295 mm.
MACAN (95B)	02/14 >	BPW-101	ANTERIORE (FRONT)	95B907253	245 mm.
MACAN (95B)	02/14 >	BPW-300	POSTERIORE (REAR)	4G0615121	215 mm.
PANAREMA (970)	05/10 > 10/16	BPW-042	ANTERIORE (FRONT)	95861236500	296 mm.
PANAREMA (970)	05/10 > 10/16	BPW-193	ANTERIORE (FRONT)	95561236560	375 mm.

N.B.: I CODICI O.E. ED IL LORO TESTO SONO RIPORTATI SOLO A TITOLO INDICATIVO
THE O.E. CODES AND THEIR TEXT ARE REPORTED ONLY FOR INDICATIVE PURPOSE

APPLICAZIONE (APPLICATION)	ANNO (YEAR)	CODICE (CODE)	LATO (SIDE)	O.E. (OR. NUMBER)	LUNGH. (LENGHT)
ARTEON (3H7 - 3H8)	03/17 >	BPW-312	ANTERIORE (FRONT)	8V0615437	170 mm.
CRAFTER 30-35 (2E - 2F)	04/06 > 12/16	BPW-004	ANT. - POST. (FRONT - REAR)	2E0906206A 2E0906206C	105 mm.
CRAFTER 30-35 (2E - 2F)	04/06 > 12/16	BPW-007	ANT. - POST. (FRONT - REAR)	2E0906206G	95 mm.
CRAFTER 30-50 (2E - 2F)	04/06 > 12/16	BPW-018	POSTERIORE (REAR)	2E0906206B	85 mm.
CRAFTER (SY - SX - SZ)	09/16 >	BPW-127	POSTERIORE (REAR)	2N0615437 2N0615437B	220 mm.
CRAFTER (SY - SX - SZ)	09/16 >	BPW-129	POSTERIORE (REAR)	65259370001	280 mm.
GOLF IV	09/02 > 06/05	BPW-184	ANTERIORE (FRONT)	1J0615121	270 mm.
GOLF VII (5G1 - BQ1 - BE1 - BE2)	08/12 > 08/20	BPW-312	ANTERIORE (FRONT)	8V0615437	170 mm.
GOLF VII SPORTVAN (AM1 - AN1)	02/14 > 08/20	BPW-312	ANTERIORE (FRONT)	8V0615437	170 mm.
GOLF VII VARIANT (BA5 - BV5)	04/13 > 08/20	BPW-312	ANTERIORE (FRONT)	8V0615437	170 mm.
GOLF VIII (CD1 - DA1)	08/19 >	BPW-312	ANTERIORE (FRONT)	8V0615437	170 mm.
GOLF VIII VARIANT (CG5 - DB5)	08/20 >	BPW-312	ANTERIORE (FRONT)	8V0615437	170 mm.
LT 28-35 II	05/96 > 07/06	BPW-012	ANT. - POST. (FRONT - REAR)	2D0919351	210 mm.
LT 28-35 II	05/96 > 07/06	BPW-061	ANT. - POST. (FRONT - REAR)	2D0919351A	190 mm.
LT 28-46 II	05/96 > 07/06	BPW-012	ANT. - POST. (FRONT - REAR)	2D0919351	210 mm.
LT 28-46 II	05/96 > 07/06	BPW-061	ANT. - POST. (FRONT - REAR)	2D0919351A	190 mm.

N.B.: I CODICI O.E. ED IL LORO TESTO SONO RIPORTATI SOLO A TITOLO INDICATIVO
THE O.E. CODES AND THEIR TEXT ARE REPORTED ONLY FOR INDICATIVE PURPOSE

APPLICAZIONE (APPLICATION)	ANNO (YEAR)	CODICE (CODE)	LATO (SIDE)	O.E. (OR. NUMBER)	LUNGH. (LENGHT)
PASSAT (B8) PASSAT VARIANT (B8)	08/14 >	BPW-312	ANTERIORE (FRONT)	8V0615437	170 mm.
TIGUAN (AD1 - AX1) TIGUAN ALLSPACE (BW2 - BJ2)	01/16 >	BPW-312	ANTERIORE (FRONT)	8V0615437	170 mm.
TOUAREG (7LA - 7L6 - 7L7)	10/02 > 05/10	BPW-014	ANTERIORE (FRONT)	7L0907637 8J0615437	420 mm.
TOUAREG (7LA - 7L6 - 7L7)	10/02 > 05/10	BPW-021	POSTERIORE (REAR)	7L0907637B 7L0907637C	255 mm.
TOUAREG (7P5 - 7P6)	01/10 > 03/18	BPW-036	ANTERIORE (FRONT)	7P0907637	326 mm.
TOUAREG (7P5 - 7P6)	01/10 > 03/18	BPW-042	ANTERIORE (FRONT)	7P0907637A	296 mm.
TOUAREG (7P5 - 7P6)	01/10 > 03/18	BPW-027	POSTERIORE (REAR)	7P0907637C	140 mm.
TOUAREG (CR7 - RC8)	11/17 >	BPW-031	ANTERIORE (FRONT)	4M0615121R 4M0615121S 4M0615121AB	400 mm.
TOUAREG (CR7 - RC8)	11/17 >	BPW-041	POSTERIORE (REAR)	4M0615121P 8W0615121E	390 mm.
TOURAN (5T1)	05/15 >	BPW-312	ANTERIORE (FRONT)	8V0615437	170 mm.
T-ROC (AD1) T-ROC CABRIO (AC7 - AC8)	07/17 >	BPW-312	ANTERIORE (FRONT)	8V0615437	170 mm.

IMMAGINI

IMAGES

Japanparts®



IMMAGINI - IMAGES

BPW-001



BPW-002



BPW-003

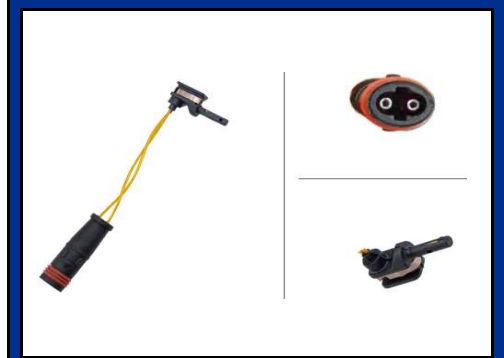

BPW-004



BPW-005



BPW-006



BPW-007



BPW-008



BPW-010



BPW-011



BPW-012



BPW-013



N.B.: I CODICI O.E. ED IL LORO TESTO SONO RIPORTATI SOLO A TITOLO INDICATIVO
THE O.E. CODES AND THEIR TEXT ARE REPORTED ONLY FOR INDICATIVE PURPOSE

IMMAGINI - IMAGES

BPW-014



BPW-015



BPW-016



BPW-018



BPW-019

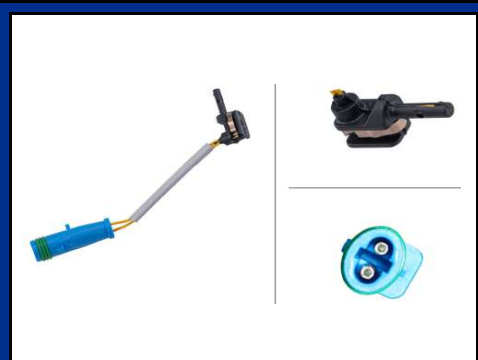

BPW-021



BPW-022



BPW-025



BPW-026



BPW-027



BPW-028



BPW-029



N.B.: I CODICI O.E. ED IL LORO TESTO SONO RIPORTATI SOLO A TITOLO INDICATIVO
THE O.E. CODES AND THEIR TEXT ARE REPORTED ONLY FOR INDICATIVE PURPOSE

IMMAGINI - IMAGES

BPW-030



BPW-031



BPW-032



BPW-034



BPW-035



BPW-036



BPW-037



BPW-038



BPW-039



BPW-040

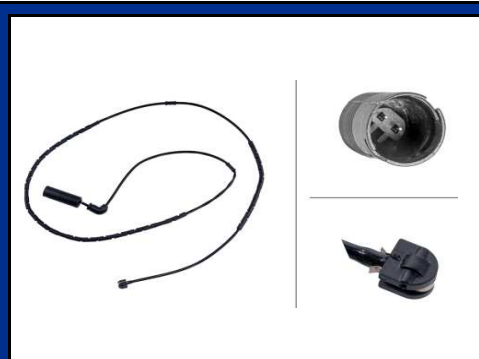

BPW-041



BPW-042



N.B.: I CODICI O.E. ED IL LORO TESTO SONO RIPORTATI SOLO A TITOLO INDICATIVO
 THE O.E. CODES AND THEIR TEXT ARE REPORTED ONLY FOR INDICATIVE PURPOSE

IMMAGINI - IMAGES

BPW-043



BPW-044



BPW-045



BPW-047



BPW-049



BPW-050



BPW-051



BPW-053



BPW-054



BPW-055



BPW-056



BPW-057



N.B.: I CODICI O.E. ED IL LORO TESTO SONO RIPORTATI SOLO A TITOLO INDICATIVO
THE O.E. CODES AND THEIR TEXT ARE REPORTED ONLY FOR INDICATIVE PURPOSE

IMMAGINI - IMAGES

BPW-058



BPW-059



BPW-060



BPW-061

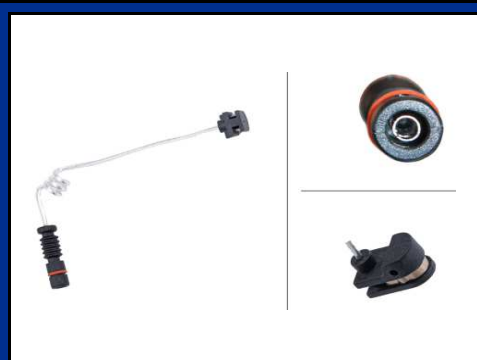

BPW-062



BPW-063



BPW-065



BPW-067



BPW-068



BPW-070



BPW-071



BPW-073



N.B.: I CODICI O.E. ED IL LORO TESTO SONO RIPORTATI SOLO A TITOLO INDICATIVO
 THE O.E. CODES AND THEIR TEXT ARE REPORTED ONLY FOR INDICATIVE PURPOSE

IMMAGINI - IMAGES

BPW-074



BPW-076



BPW-077



BPW-078



BPW-079



BPW-080



BPW-081



BPW-082



BPW-083



BPW-084



BPW-085



BPW-086



N.B.: I CODICI O.E. ED IL LORO TESTO SONO RIPORTATI SOLO A TITOLO INDICATIVO
 THE O.E. CODES AND THEIR TEXT ARE REPORTED ONLY FOR INDICATIVE PURPOSE

IMMAGINI - IMAGES

BPW-087



BPW-088



BPW-090

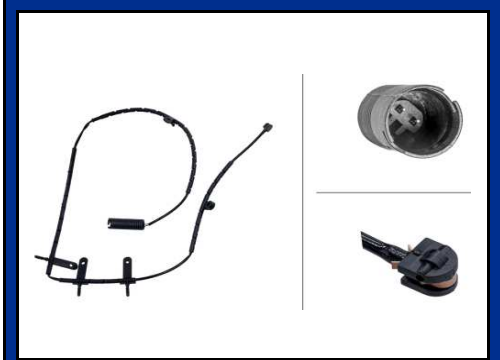

BPW-091



BPW-092



BPW-095



BPW-096

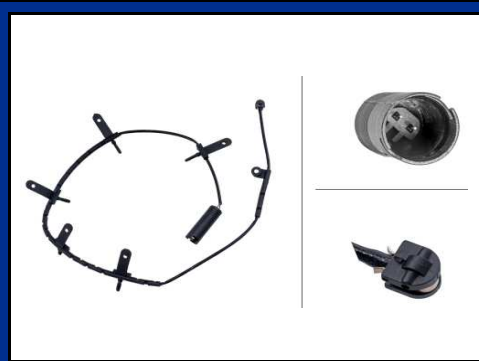

BPW-098



BPW-099



BPW-100



BPW-101



BPW-102



N.B.: I CODICI O.E. ED IL LORO TESTO SONO RIPORTATI SOLO A TITOLO INDICATIVO
 THE O.E. CODES AND THEIR TEXT ARE REPORTED ONLY FOR INDICATIVE PURPOSE

IMMAGINI - IMAGES

BPW-105



BPW-106



BPW-107



BPW-108



BPW-109



BPW-111



BPW-112



BPW-113



BPW-114



BPW-117



BPW-119



BPW-124



N.B.: I CODICI O.E. ED IL LORO TESTO SONO RIPORTATI SOLO A TITOLO INDICATIVO
 THE O.E. CODES AND THEIR TEXT ARE REPORTED ONLY FOR INDICATIVE PURPOSE

IMMAGINI - IMAGES

BPW-126



BPW-127

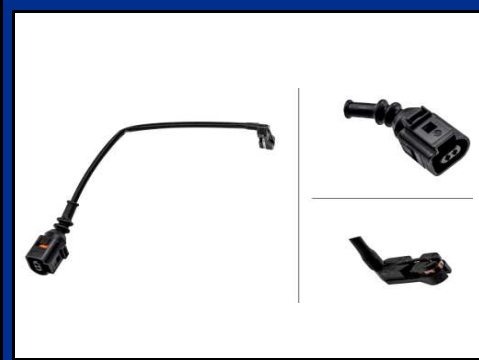

BPW-128



BPW-129



BPW-130



BPW-131



BPW-132



BPW-134



BPW-135



BPW-137



BPW-138



BPW-139



N.B.: I CODICI O.E. ED IL LORO TESTO SONO RIPORTATI SOLO A TITOLO INDICATIVO
 THE O.E. CODES AND THEIR TEXT ARE REPORTED ONLY FOR INDICATIVE PURPOSE

IMMAGINI - IMAGES

BPW-141

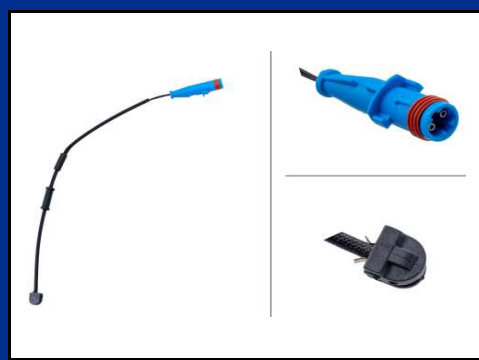

BPW-143

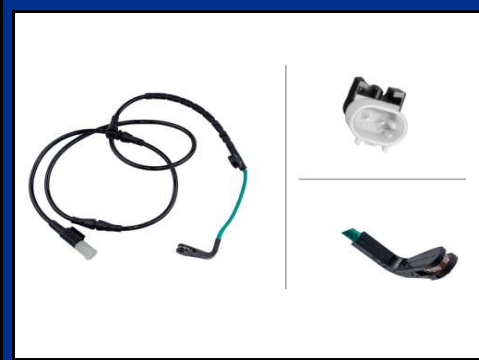

BPW-144



BPW-149



BPW-154



BPW-158



BPW-162



BPW-164



BPW-165



BPW-169

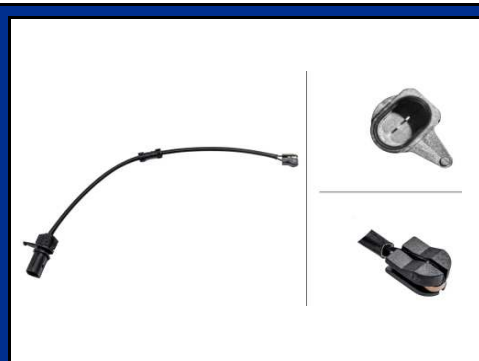

BPW-175



BPW-177



N.B.: I CODICI O.E. ED IL LORO TESTO SONO RIPORTATI SOLO A TITOLO INDICATIVO
THE O.E. CODES AND THEIR TEXT ARE REPORTED ONLY FOR INDICATIVE PURPOSE

IMMAGINI - IMAGES

BPW-178



BPW-179



BPW-180



BPW-181



BPW-184



BPW-185



BPW-186



BPW-191



BPW-193



BPW-198



BPW-203

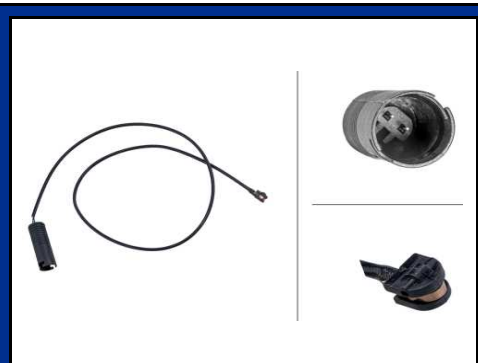

BPW-204



N.B.: I CODICI O.E. ED IL LORO TESTO SONO RIPORTATI SOLO A TITOLO INDICATIVO
 THE O.E. CODES AND THEIR TEXT ARE REPORTED ONLY FOR INDICATIVE PURPOSE

IMMAGINI - IMAGES

BPW-205



BPW-206

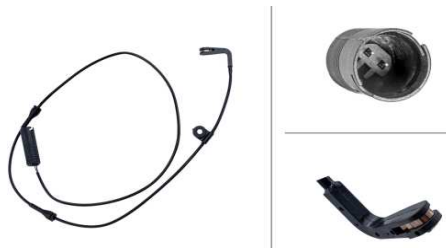

BPW-217



BPW-226



BPW-227



BPW-232



BPW-246



BPW-248

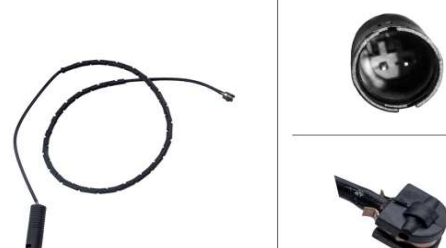

BPW-252



BPW-265



BPW-285



BPW-286

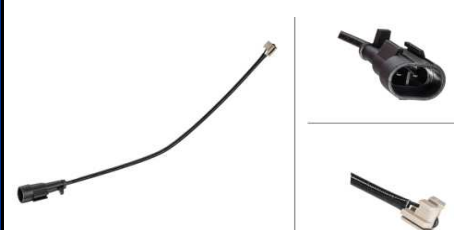

N.B.: I CODICI O.E. ED IL LORO TESTO SONO RIPORTATI SOLO A TITOLO INDICATIVO
THE O.E. CODES AND THEIR TEXT ARE REPORTED ONLY FOR INDICATIVE PURPOSE

IMMAGINI - IMAGES

BPW-287



BPW-288



BPW-289



BPW-290

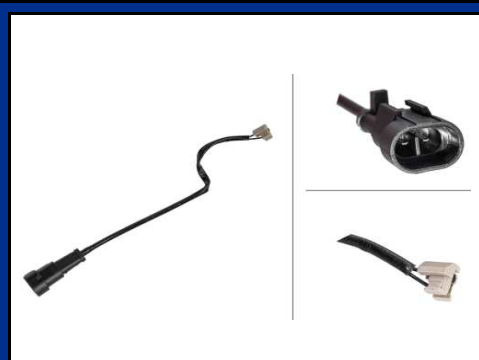

BPW-291



BPW-292

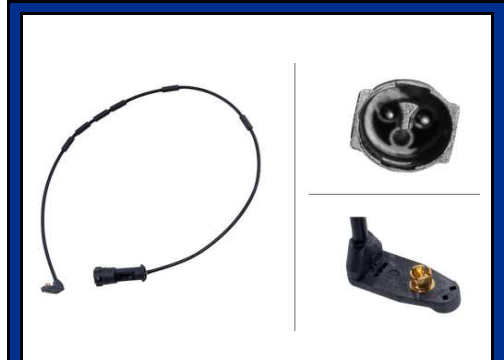

BPW-293



BPW-294

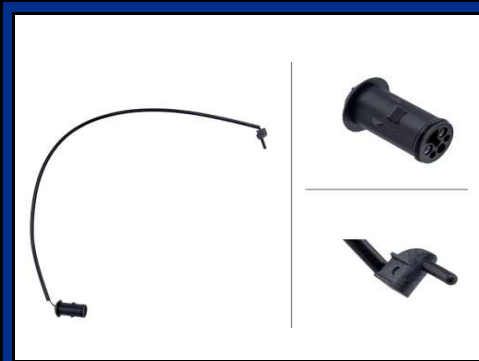

BPW-295



BPW-296



BPW-297



BPW-298



N.B.: I CODICI O.E. ED IL LORO TESTO SONO RIPORTATI SOLO A TITOLO INDICATIVO
 THE O.E. CODES AND THEIR TEXT ARE REPORTED ONLY FOR INDICATIVE PURPOSE

IMMAGINI - IMAGES

BPW-299

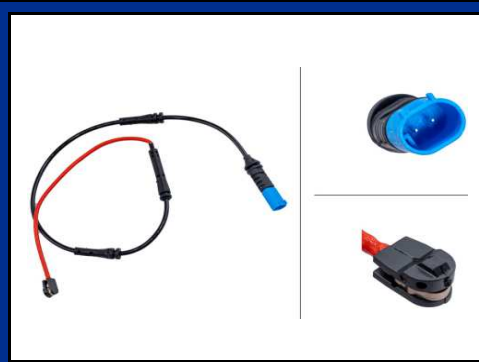

BPW-300



BPW-301



BPW-302



BPW-303

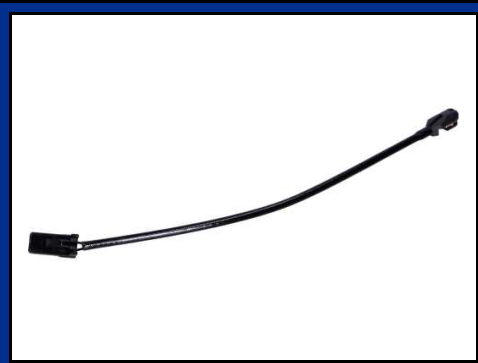

BPW-304



BPW-305



BPW-306



BPW-307



BPW-308



BPW-309

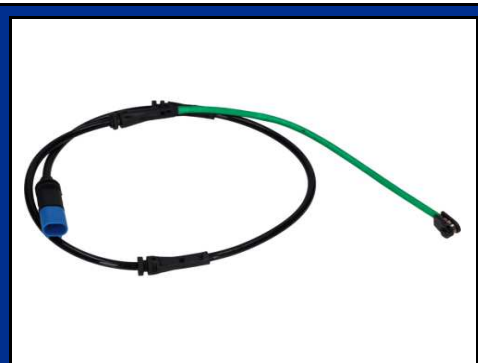

BPW-310



N.B.: I CODICI O.E. ED IL LORO TESTO SONO RIPORTATI SOLO A TITOLO INDICATIVO
 THE O.E. CODES AND THEIR TEXT ARE REPORTED ONLY FOR INDICATIVE PURPOSE

IMMAGINI - IMAGES

BPW-311



BPW-312



BPW-313



BPW-314



N.B.: I CODICI O.E. ED IL LORO TESTO SONO RIPORTATI SOLO A TITOLO INDICATIVO
 THE O.E. CODES AND THEIR TEXT ARE REPORTED ONLY FOR INDICATIVE PURPOSE

ABBINAMENTO PASTIGLIE
PAD MATCHING



CODICE (CODE)	CODICE PASTIGLIE FRENO (BRAKE PADS CODE)
BPW-001	PA-0523AF - PA-0528AF - PA-0532AF PA-0538AF - PA-915AF - PA-920AF PA-921AF - PP-0515AF - PP-0522AF PP-0528AF - PP-0529AF - PP-0535AF PP-0536AF
BPW-002	PA-0067AF - PA-0068AF - PA-0069AF PA-0503AF - PA-0504AF - PA-0512AF PA-0513AF - PA-0515AF - PA-0516AF PA-0519AF - PA-0523AF - PA-0529AF PA-0533AF - PA-0534AF - PA-0544AF PA-0547AF - PA-0549AF - PP-0501AF PP-0504AF - PP-0505AF - PP-0507AF PP-0511AF - PP-0517AF - PP-0526AF PP-0533AF - PP-911AF
BPW-003	PA-0510AF - PA-0524AF - PA-0526AF
BPW-004	PA-0538AF - PA-0539AF - PP-0528AF
BPW-005	PA-0067AF - PA-0068AF - PA-0069AF PA-0503AF - PA-0504AF - PA-0511AF PA-0512AF - PA-0513AF - PA-0515AF PA-0516AF - PA-0519AF - PA-0522AF PA-0523AF - PA-0529AF - PA-0533AF PA-0534AF - PA-0544AF - PA-0547AF PP-911AF
BPW-006	PA-0916AF
BPW-007	PA-0523AF - PA-0527AF - PA-0528AF PA-0532AF - PA-0539AF - PA-0546AF PA-915AF - PA-921AF - PP-0515AF PP-0522AF - PP-0528AF - PP-0529AF PP-0535AF - PP-0536AF
BPW-008	PA-0103AF - PA-0104AF - PA-0105AF PA-0106AF
BPW-010	PP-0101AF - PP-0102AF - PP-0121AF
BPW-011	PP-0103AF - PP-0118AF

CODICE (CODE)	CODICE PASTIGLIE FRENO (BRAKE PADS CODE)
BPW-012	PA-0541AF - PA-0553AF - PP-0513AF
BPW-013	PA-0124AF - PA-0125AF - PA-0126AF
BPW-014	PA-0931AF - PA-0933AF - PA-0949AF
BPW-015	PA-0107AF - PA-0109AF - PA-0135AF
BPW-016	PP-0112AF - PP-0113AF
BPW-018	PP-0523AF
BPW-019	PA-0554AF - PP-0530AF
BPW-021	PP-0915AF - PP-0918AF - PP-0919AF
BPW-022	PA-0107AF - PA-0128AF - PA-2029AF
BPW-025	PA-0026AF - PA-0060AF - PA-0505AF PA-0506AF - PA-0508AF - PA-0520AF PA-0530AF - PP-0502AF - PP-0504AF PP-0510AF - PP-911AF
BPW-026	PP-0112AF - PP-0113AF
BPW-027	PP-0925AF
BPW-028	PP-0115AF
BPW-029	PA-0106AF
BPW-030	PP-0112AF

CODICE (CODE)	CODICE PASTIGLIE FRENO (BRAKE PADS CODE)
BPW-031	PA-0932AF
BPW-032	PP-L09AF
BPW-034	PA-0049AF - PA-0108AF - PA-0109AF PA-0135AF
BPW-035	PA-L07AF
BPW-036	PA-0933AF
BPW-037	PA-0048AF - PA-0049AF - PA-0101AF PA-0113AF - PA-0114AF
BPW-038	PA-0132AF - PA-0134AF
BPW-039	PA-0005AF - PA-0006AF
BPW-040	PP-L00AF
BPW-041	PP-0910AF - PP-0911AF - PP-0929AF
BPW-042	PA-0948AF - PA-0998AF
BPW-043	PA-0048AF - PA-0115AF - PA-0122AF
BPW-044	PP-0109AF - PP-0116AF - PP-0117AF
BPW-045	PA-0113AF - PA-0114AF
BPW-047	PP-L01AF - PP-L08AF
BPW-049	PA-0107AF - PA-0128AF - PA-2029AF

CODICE (CODE)	CODICE PASTIGLIE FRENO (BRAKE PADS CODE)
BPW-050	PA-L12AF
BPW-051	PA-0925AF - PA-0930AF
BPW-053	PP-0112AF - PP-0113AF
BPW-054	PA-0413AF - PA-0525AF
BPW-055	PP-0109AF - PP-0111AF
BPW-056	PP-0008AF - PP-0108AF
BPW-057	PA-0128AF - PA-2029AF
BPW-058	PP-0109AF - PP-0116AF - PP-0117AF
BPW-059	PP-0119AF
BPW-060	PA-0132AF - PA-0134AF
BPW-061	PA-0537AF - PA-0540AF - PP-0512AF PP-0521AF
BPW-062	PA-0048AF - PA-0113AF - PA-0114AF
BPW-065	PP-0100AF
BPW-067	PA-0108AF - PA-0136AF - PA-0137AF
BPW-068	PA-0136AF
BPW-070	PP-0313AF

CODICE (CODE)	CODICE PASTIGLIE FRENO (BRAKE PADS CODE)
BPW-071	PP-L00AF
BPW-073	PP-L00AF
BPW-074	PP-0113AF
BPW-076	PA-0048AF - PA-0108AF
BPW-077	PP-0119AF
BPW-078	PA-0121AF - PA-0131AF
BPW-079	PA-0113AF
BPW-080	PA-L08AF
BPW-081	PA-0112AF - PA-0121AF
BPW-082	PP-0115AF
BPW-083	PA-0917AF - PA-0918AF - PA-0962AF PA-0963AF
BPW-084	PP-L00AF
BPW-085	PA-0119AF - PA-0121AF
BPW-086	PA-0108AF - PA-0136AF - PA-0137AF
BPW-087	PP-L09AF
BPW-088	PA-0048AF - PA-0113AF - PA-0114AF

CODICE (CODE)	CODICE PASTIGLIE FRENO (BRAKE PADS CODE)
BPW-090	PP-0015AF
BPW-091	PP-0313AF
BPW-092	PA-0948AF - PA-0976AF
BPW-095	PA-L14AF
BPW-096	PA-0027AF - PA-0136AF
BPW-098	PA-0924AF
BPW-099	PA-L01AF
BPW-100	PA-L12AF
BPW-101	PA-0998AF
BPW-102	PP-0112AF - PP-0113AF
BPW105	PA-L14AF
BPW-106	PA-L08AF - PA-L15AF
BPW-107	PA-0231AF - PA-0530AF - PP-0519AF
BPW-108	PP-0115AF
BPW-109	PP-L01AF
BPW-111	PP-0110AF

CODICE (CODE)	CODICE PASTIGLIE FRENO (BRAKE PADS CODE)
BPW-112	PA-0122AF
BPW-113	PP-0109AF
BPW-114	PP-0112AF - PP-0113AF
BPW-117	PP-0109AF - PP-0111AF
BPW-119	PA-0111AF
BPW-124	PP-0112AF - PP-0113AF
BPW-126	PA-0005AF - PP-0105AF
BPW-127	PP-0914AF
BPW-128	PA-0048AF - PA-0113AF - PA-0114AF
BPW-129	PP-0914AF
BPW-130	PP-0313AF
BPW-131	PA-0111AF - PA-0112AF
BPW-132	PA-L01AF - PA-L05AF - PA-L06AF PA-L07AF
BPW-134	PA-0132AF - PA-0133AF - PA-0134AF
BPW-135	PA-L14AF - PP-0313AF
BPW-137	PA-0130AF

CODICE (CODE)	CODICE PASTIGLIE FRENO (BRAKE PADS CODE)
BPW-138	PA-2029AF
BPW-139	PA-L12AF - PA-L14AF
BPW-141	PA-0074AF - PA-027AF
BPW-143	PA-L01AF - PA-L07AF
BPW-144	PP-0008AF - PP-0108AF
BPW-149	PA-0925AF
BPW-154	PA-0231AF - PA-0530AF - PP-0519AF
BPW-158	PA-0132AF - PA-0134AF
BPW-162	PA-0029AF - PA-0073AF - PA-0404AF PA-0410AF - PA-0412AF
BPW-164	PP-0932AF
BPW-165	PA-0339AF
BPW-169	PA-0958AF
BPW-175	PA-0409AF
BPW-177	PA-09102AF - PP-0932AF - PA-09107AF
BPW-178	PA-0141AF - PA-0111AF - PP-0106AF
BPW-179	PA-0339AF - PA-0340AF

N.B.: I CODICI O.E. ED IL LORO TESTO SONO RIPORTATI SOLO A TITOLO INDICATIVO
THE O.E. CODES AND THEIR TEXT ARE REPORTED ONLY FOR INDICATIVE PURPOSE

CODICE (CODE)	CODICE PASTIGLIE FRENO (BRAKE PADS CODE)
BPW-180	PA-0404AF
BPW-181	PP-0104AF - PP-0112AF
BPW-184	PA-921AF
BPW-185	PP-0913AF
BPW-186	PA-L06AF
BPW-191	PP-L00AF
BPW-193	PA-0931AF
BPW-198	PA-0048AF - PA-0114AF
BPW-203	PP-0105AF
BPW-204	PP-L00AF
BPW-205	PA-0113AF
BPW-206	PP-0110AF
BPW-217	PP-L02AF
BPW-226	PA-0074AF
BPW-227	PP-0009AF
BPW-232	PP-0112AF

CODICE (CODE)	CODICE PASTIGLIE FRENO (BRAKE PADS CODE)
BPW-246	PA-0032AF - PA-0074AF
BPW-248	PP-0009AF
BPW-252	PP-0216AF - PP-0314AF
BPW-265	PA-09102AF - PA-09107AF
BPW-285	PA-0014AF - PP-0219AF
BPW-286	PA-0013AF
BPW-287	PP-0307AF
BPW-288	PA-0011AF - PA-0012AF - PA-0233AF PA-0235AF - PA-161AF
BPW-289	PA-0235AF
BPW-290	PA-0013AF
BPW-291	PP-0307AF
BPW-292	PA-0410AF - PA-390AF
BPW-293	PA-376AF
BPW-294	PA-161AF
BPW-295	PA-0517AF
BPW-296	PA-0618AF - PA-0620AF - PA-0657AF

COMPARATIVA
CROSS REFERENCE



A.B.S.	CODICE (CODE)	A.B.S.	CODICE (CODE)	APEC	CODICE (CODE)	APEC	CODICE (CODE)
39514	BPW-203	39782	BPW-032	BWR5037	BPW-107	WIR5262	BPW-108
39526	BPW-178	39783	BPW-035	BWR5039	BPW-001	WIR5266	BPW-134
39583	BPW-162	39797	BPW-015	BWR5048	BPW-060	WIR5267	BPW-193
39595	BPW-154	39808	BPW-053	BWR5086	BPW-114	WIR5269	BPW-076
39597	BPW-107	39809	BPW-049	BWR5109	BPW-015	WIR5270	BPW-088
39601	BPW-289	39812	BPW-298	BWR5135	BPW-203	WIR5274	BPW-134
39616	BPW-227	39813	BPW-299	KIT100	BPW-025	WIR5281	BPW-287
39618	BPW-246	39814	BPW-074	KIT101	BPW-054	WIR5297	BPW-015
39619	BPW-141	39815	BPW-057	KIT113	BPW-126	WIR5316	BPW-185
39625	BPW-007	39909	BPW-050	KIT113	BPW-203	WIR5319	BPW-050
39627	BPW-001	39911	BPW-041	KIT114	BPW-126	WIR5323	BPW-041
39630	BPW-047	39914	BPW-083	KIT118	BPW-292	WIR5324	BPW-031
39634	BPW-295	39921	BPW-031	KIT120	BPW-294	WIR5325	BPW-083
39640	BPW-158	39924	BPW-022	KIT124	BPW-180	WIR5327	BPW-022
39641	BPW-060	39925	BPW-026	KIT125	BPW-175	WIR5328	BPW-026
39643	BPW-099	39974	BPW-127	KIT127	BPW-293	WIR5331	BPW-149
39653	BPW-018	39975	BPW-129	KIT128	BPW-085	WIR5348	BPW-100
39664	BPW-265	39976	BPW-139	KIT129	BPW-111	WIR5349	BPW-139
39665	BPW-184	39978	BPW-091	KIT131	BPW-206	WIR5350	BPW-091
39672	BPW-296	39981	BPW-169	KIT132	BPW-012	WIR5355	BPW-087
39675	BPW-144	39982	BPW-124	KIT136	BPW-248	WIR5357	BPW-106
39676	BPW-056	39983	BPW-135	KIT137	BPW-040	WIR5375	BPW-169
39677	BPW-013	39985	BPW-106	KIT138	BPW-039		
39681	BPW-205	39986	BPW-087	KIT178	BPW-107		
39684	BPW-108			WIR5113	BPW-203		
39685	BPW-016			WIR5139	BPW-141		
39686	BPW-134			WIR5175	BPW-107		
39687	BPW-029			WIR5178	BPW-007		
39688	BPW-044			WIR5187	BPW-099		
39689	BPW-076			WIR5190	BPW-060		
39690	BPW-088			WIR5192	BPW-158		
39692	BPW-079			WIR5217	BPW-184		
39693	BPW-181			WIR5224	BPW-290		
39694	BPW-062			WIR5228	BPW-295		
39695	BPW-038			WIR5230	BPW-080		
39697	BPW-030			WIR5231	BPW-032		
39698	BPW-068			WIR5232	BPW-289		
39699	BPW-065			WIR5233	BPW-067		
39700	BPW-067			WIR5234	BPW-059		
39701	BPW-059			WIR5235	BPW-205		
39703	BPW-027			WIR5236	BPW-079		
39704	BPW-036			WIR5238	BPW-062		
39713	BPW-290			WIR5239	BPW-144		
39724	BPW-005			WIR5240	BPW-056		
39725	BPW-193			WIR5247	BPW-036		
39736	BPW-198			WIR5248	BPW-027		
39747	BPW-193			WIR5249	BPW-068		
39749	BPW-114			WIR5250	BPW-065		
39751	BPW-008			WIR5251	BPW-013		
39752	BPW-010			WIR5252	BPW-016		
39756	BPW-305			WIR5254	BPW-029		
39769	BPW-287			WIR5255	BPW-030		
39774	BPW-149			WIR5256	BPW-044		
39777	BPW-185			WIR5257	BPW-198		
39781	BPW-080			WIR5259	BPW-181		

N.B.: I CODICI O.E. ED IL LORO TESTO SONO RIPORTATI SOLO A TITOLO INDICATIVO
THE O.E. CODES AND THEIR TEXT ARE REPORTED ONLY FOR INDICATIVE PURPOSE

ATE	CODICE (CODE)	ATE	CODICE (CODE)	BENDIX	CODICE (CODE)	BENDIX	CODICE (CODE)
600929	BPW-014	620289	BPW-038	581303	BPW-178	581482	BPW-030
620005	BPW-018	620290	BPW-044	581304	BPW-025	581488	BPW-108
620006	BPW-008	620291	BPW-134	581305	BPW-054	581489	BPW-062
620007	BPW-010	620294	BPW-181	581307	BPW-302	581490	BPW-067
620067	BPW-005	620295	BPW-198	581328	BPW-306	581491	BPW-059
620106	BPW-184	620296	BPW-056	581329	BPW-178	581492	BPW-065
620206	BPW-203	620297	BPW-079	581330	BPW-126	581493	BPW-068
620207	BPW-126	620298	BPW-013	581330	BPW-203	581494	BPW-036
620214	BPW-178	620312	BPW-016	581331	BPW-126	581500	BPW-029
620218	BPW-111	620313	BPW-300	581332	BPW-025	581508	BPW-265
620219	BPW-085	620401	BPW-025	581333	BPW-025	587047	BPW-004
620220	BPW-039	620402	BPW-054	581334	BPW-301	587048	BPW-018
620221	BPW-040	620407	BPW-012	581335	BPW-301	581300B	BPW-119
620222	BPW-206	620411	BPW-154	581341	BPW-292	581301B	BPW-217
620225	BPW-078	620412	BPW-107	581344	BPW-306	581303B	BPW-178
620226	BPW-071	620416	BPW-002	581357	BPW-071	581330B	BPW-203
620227	BPW-131	620417	BPW-061	581359	BPW-248	581337B	BPW-252
620228	BPW-040	620418	BPW-007	581361	BPW-107	581349B	BPW-164
620229	BPW-227	620424	BPW-004	581365	BPW-078	581362B	BPW-177
620230	BPW-112	620425	BPW-001	581367	BPW-131	581366B	BPW-191
620231	BPW-113	620701	BPW-302	581368	BPW-154	581379B	BPW-003
620235	BPW-096	620702	BPW-302	581370	BPW-307	581383B	BPW-002
620236	BPW-090	620704	BPW-301	581371	BPW-293	BBI1245	BPW-305
620237	BPW-043	620707	BPW-292	581372	BPW-206	BBI1246	BPW-179
620238	BPW-055	620710	BPW-307	581373	BPW-175		
620239	BPW-117	620711	BPW-175	581376	BPW-180		
620240	BPW-081	620712	BPW-301	581377	BPW-111		
620241	BPW-084	620714	BPW-180	581378	BPW-040		
620242	BPW-037	620715	BPW-293	581380	BPW-085		
620243	BPW-028	620718	BPW-162	581385	BPW-141		
620247	BPW-128	620719	BPW-226	581386	BPW-226		
620248	BPW-043	620720	BPW-141	581387	BPW-227		
620249	BPW-086	620811	BPW-006	581392	BPW-076		
620250	BPW-077	620929	BPW-014	581401	BPW-045		
620252	BPW-060	620930	BPW-021	581402	BPW-060		
620253	BPW-058	620931	BPW-265	581404	BPW-001		
620254	BPW-081	620936	BPW-193	581404	BPW-007		
620255	BPW-158	620942	BPW-011	581410	BPW-047		
620264	BPW-037	620959	BPW-019	581411	BPW-099		
620266	BPW-128	620975	BPW-083	581415	BPW-158		
620267	BPW-045	620981	BPW-034	581417	BPW-044		
620268	BPW-060	620983	BPW-015	581426	BPW-246		
620269	BPW-058	620987	BPW-022	581451	BPW-038		
620270	BPW-158	620998	BPW-287	581461	BPW-027		
620272	BPW-037	621302	BPW-306	581467	BPW-300		
620273	BPW-043	621304	BPW-288	581471	BPW-019		
620274	BPW-055	621306	BPW-047	581472	BPW-008		
620275	BPW-117	621307	BPW-186	581473	BPW-088		
620277	BPW-086	621308	BPW-204	581475	BPW-013		
620278	BPW-077	622802	BPW-248	581476	BPW-016		
620282	BPW-144	622901	BPW-294	581477	BPW-205		
620283	BPW-205			581478	BPW-079		
620284	BPW-076			581479	BPW-144		
620286	BPW-062			581480	BPW-056		
620287	BPW-088			581481	BPW-181		

N.B.: I CODICI O.E. ED IL LORO TESTO SONO RIPORTATI SOLO A TITOLO INDICATIVO
THE O.E. CODES AND THEIR TEXT ARE REPORTED ONLY FOR INDICATIVE PURPOSE

BREMBO	CODICE (CODE)	BREMBO	CODICE (CODE)	BREMSI	CODICE (CODE)	BREMSI	CODICE (CODE)
A 00 288	BPW-018	A 00 471	BPW-002	WI0401	BPW-015	WI0617	BPW-117
A 00 291	BPW-007	A 00 472	BPW-114	WI0403	BPW-102	WI0618	BPW-246
A 00 295	BPW-248	A 00 473	BPW-008	WI0404	BPW-138	WI0619	BPW-141
A 00 296	BPW-096	A 00 474	BPW-010	WI0414	BPW-105	WI0621	BPW-204
A 00 297	BPW-090	A 00 478	BPW-080	WI0415	BPW-165	WI0623	BPW-132
A 00 298	BPW-077	A 00 479	BPW-032	WI0476	BPW-309	WI0625	BPW-007
A 00 299	BPW-086	A 00 481	BPW-297	WI0501	BPW-025	WI0627	BPW-001
A 00 300	BPW-302	A 00 482	BPW-098	WI0502	BPW-119	WI0630	BPW-047
A 00 308	BPW-307	A 00 483	BPW-019	WI0505	BPW-217	WI0631	BPW-004
A 00 309	BPW-175	A 00 484	BPW-006	WI0507	BPW-054	WI0634	BPW-295
A 00 310	BPW-301	A 00 487	BPW-198	WI0510	BPW-302	WI0635	BPW-128
A 00 333	BPW-177	A 00 494	BPW-185	WI0514	BPW-203	WI0637	BPW-045
A 00 338	BPW-265	A 00 498	BPW-035	WI0515	BPW-126	WI0639	BPW-058
A 00 341	BPW-164	A 00 499	BPW-101	WI0517	BPW-301	WI0640	BPW-158
A 00 345	BPW-193	A 00 499	BPW-092	WI0518	BPW-301	WI0641	BPW-060
A 00 346	BPW-021	A 00 504	BPW-291	WI0521	BPW-252	WI0643	BPW-099
A 00 350	BPW-025	A 00 505	BPW-287	WI0526	BPW-178	WI0644	BPW-109
A 00 351	BPW-288	A 00 506	BPW-015	WI0527	BPW-292	WI0645	BPW-086
A 00 353	BPW-005	A 00 507	BPW-011	WI0531	BPW-191	WI0646	BPW-077
A 00 377	BPW-019	A 00 509	BPW-034	WI0532	BPW-175	WI0653	BPW-018
A 00 377	BPW-003	A 00 516	BPW-178	WI0534	BPW-111	WI0664	BPW-265
A 00 408	BPW-285	A 00 518	BPW-310	WI0557	BPW-307	WI0665	BPW-184
A 00 410	BPW-290	A 00 525	BPW-073	WI0559	BPW-180	WI0672	BPW-296
A 00 422	BPW-013	A 00 532	BPW-070	WI0560	BPW-293	WI0675	BPW-144
A 00 423	BPW-082	A 00 533	BPW-091	WI0565	BPW-012	WI0676	BPW-056
A 00 425	BPW-232	A 00 557	BPW-138	WI0566	BPW-085	WI0677	BPW-013
A 00 426	BPW-205	A 00 585	BPW-308	WI0572	BPW-306	WI0678	BPW-082
A 00 427	BPW-144			WI0576	BPW-177	WI0680	BPW-232
A 00 430	BPW-108			WI0577	BPW-164	WI0681	BPW-205
A 00 431	BPW-016			WI0578	BPW-206	WI0684	BPW-108
A 00 432	BPW-134			WI0581	BPW-039	WI0685	BPW-016
A 00 433	BPW-029			WI0582	BPW-040	WI0686	BPW-134
A 00 434	BPW-044			WI0583	BPW-162	WI0687	BPW-029
A 00 435	BPW-076			WI0584	BPW-078	WI0689	BPW-076
A 00 436	BPW-088			WI0585	BPW-071	WI0690	BPW-088
A 00 437	BPW-063			WI0587	BPW-131	WI0691	BPW-063
A 00 438	BPW-079			WI0590	BPW-002	WI0692	BPW-079
A 00 439	BPW-056			WI0593	BPW-248	WI0693	BPW-181
A 00 440	BPW-181			WI0595	BPW-154	WI0694	BPW-062
A 00 441	BPW-062			WI0597	BPW-107	WI0695	BPW-038
A 00 442	BPW-038			WI0601	BPW-289	WI0697	BPW-030
A 00 444	BPW-068			WI0602	BPW-043	WI0698	BPW-068
A 00 445	BPW-065			WI0603	BPW-055	WI0699	BPW-065
A 00 446	BPW-067			WI0604	BPW-226	WI0700	BPW-067
A 00 447	BPW-059			WI0606	BPW-096	WI0701	BPW-059
A 00 451	BPW-042			WI0607	BPW-090	WI0702	BPW-042
A 00 452	BPW-027			WI0608	BPW-112	WI0703	BPW-027
A 00 453	BPW-036			WI0609	BPW-113	WI0704	BPW-036
A 00 455	BPW-030			WI0610	BPW-081	WI0713	BPW-290
A 00 460	BPW-305			WI0611	BPW-084	WI0714	BPW-285
A 00 466	BPW-149			WI0612	BPW-037	WI0715	BPW-286
A 00 467	BPW-051			WI0613	BPW-028	WI0723	BPW-006
A 00 468	BPW-051			WI0614	BPW-014	WI0724	BPW-005
A 00 469	BPW-179			WI0615	BPW-021	WI0727	BPW-051
A 00 470	BPW-295			WI0616	BPW-227	WI0728	BPW-179

N.B.: I CODICI O.E. ED IL LORO TESTO SONO RIPORTATI SOLO A TITOLO INDICATIVO
THE O.E. CODES AND THEIR TEXT ARE REPORTED ONLY FOR INDICATIVE PURPOSE

BREMSI	CODICE (CODE)	CIFAM	CODICE (CODE)	CIFAM	CODICE (CODE)	CIFAM	CODICE (CODE)
WI0734	BPW-300	SU.012	BPW-054	SU.221	BPW-134	SU.318	BPW-162
WI0736	BPW-198	SU.093	BPW-293	SU.222	BPW-086	SU.319	BPW-246
WI0747	BPW-193	SU.011	BPW-025	SU.223	BPW-077	SU.320	BPW-141
WI0749	BPW-114	SU.072	BPW-217	SU.224	BPW-006	SU.321	BPW-179
WI0751	BPW-008	SU.082	BPW-252	SU.225K	BPW-285	SU.322	BPW-305
WI0752	BPW-010	SU.083	BPW-126	SU.226K	BPW-289	SU.324	BPW-067
WI0756	BPW-305	SU.083	BPW-203	SU.227K	BPW-290	SU.325	BPW-059
WI0762	BPW-143	SU.088	BPW-306	SU.229	BPW-047	SU.329	BPW-287
WI0768	BPW-019	SU.090	BPW-301	SU.242	BPW-296	SU.330	BPW-019
WI0769	BPW-287	SU.091	BPW-302	SU.246	BPW-184	SU.331	BPW-092
WI0771	BPW-312	SU.092	BPW-111	SU.253	BPW-143	SU.332	BPW-101
WI0774	BPW-149	SU.099	BPW-012	SU.255	BPW-099	SU.338	BPW-015
WI0777	BPW-185	SU.100K	BPW-288	SU.256	BPW-186	SU.340	BPW-297
WI0781	BPW-080	SU.101K	BPW-294	SU.259	BPW-128	SU.341	BPW-291
WI0782	BPW-032	SU.104	BPW-085	SU.260K	BPW-311	SU.345	BPW-083
WI0783	BPW-035	SU.108	BPW-292	SU.264	BPW-265	SU.346	BPW-313
WI0788	BPW-044	SU.112	BPW-039	SU.265	BPW-164	SU.347	BPW-031
WI0798	BPW-297	SU.113	BPW-040	SU.271	BPW-036	SU.348	BPW-041
WI0800	BPW-291	SU.123	BPW-248	SU.274	BPW-027	SU.349	BPW-310
WI0801	BPW-034	SU.129	BPW-002	SU.275	BPW-108	SU.350	BPW-022
WI0808	BPW-053	SU.129	BPW-005	SU.276	BPW-082	SU.351	BPW-026
WI0809	BPW-049	SU.129	BPW-003	SU.278	BPW-008	SU.352	BPW-070
WI0812	BPW-298	SU.142	BPW-180	SU.279	BPW-010	SU.353	BPW-050
WI0813	BPW-299	SU.143	BPW-307	SU.280	BPW-029	SU.357	BPW-130
WI0814	BPW-074	SU.144	BPW-175	SU.281	BPW-065	SU.361	BPW-049
WI0815	BPW-057	SU.145	BPW-226	SU.282	BPW-068	SU.362	BPW-053
WI0816	BPW-011	SU.147	BPW-131	SU.284	BPW-013	SU.364	BPW-127
WI0902	BPW-288	SU.148	BPW-206	SU.287	BPW-016	SU.365	BPW-129
WI0904	BPW-294	SU.149	BPW-096	SU.288	BPW-030	SU.366	BPW-124
WI0906	BPW-070	SU.150	BPW-043	SU.289	BPW-312	SU.368	BPW-114
WI0909	BPW-050	SU.151	BPW-112	SU.290	BPW-051	SU.372	BPW-299
WI0913	BPW-041	SU.152	BPW-078	SU.291	BPW-300	SU.373	BPW-074
WI0914	BPW-083	SU.153	BPW-132	SU.294	BPW-193	SU.374	BPW-057
WI0915	BPW-137	SU.155	BPW-071	SU.295	BPW-098	SU.376	BPW-138
WI0918	BPW-073	SU.156	BPW-204	SU.296	BPW-227	SU.377	BPW-102
WI0921	BPW-031	SU.157	BPW-055	SU.297	BPW-205	SU.379	BPW-298
WI0922	BPW-101	SU.158	BPW-113	SU.298	BPW-079	SU.380	BPW-314
WI0924	BPW-022	SU.161	BPW-107	SU.299	BPW-062	SU.383	BPW-091
WI0925	BPW-026	SU.161	BPW-154	SU.300	BPW-144	SU.384	BPW-139
WI0932	BPW-130	SU.164	BPW-001	SU.301	BPW-056	SU.385	BPW-100
WI0935	BPW-092	SU.164	BPW-007	SU.302	BPW-088	SU.387	BPW-135
WI0973	BPW-314	SU.189	BPW-090	SU.303	BPW-063	SU.388	BPW-087
WI0974	BPW-127	SU.195	BPW-081	SU.304	BPW-076	SU.389	BPW-106
WI0975	BPW-129	SU.196	BPW-084	SU.305	BPW-045	SU.390	BPW-105
WI0976	BPW-100	SU.204K	BPW-286	SU.307	BPW-198	SU.391	BPW-165
WI0977	BPW-139	SU.205	BPW-037	SU.308	BPW-181	SU.392	BPW-073
WI0978	BPW-091	SU.206	BPW-028	SU.309	BPW-038	SU.396	BPW-308
WI0979	BPW-308	SU.207	BPW-117	SU.310	BPW-044	SU.398	BPW-295
WI0981	BPW-169	SU.209	BPW-061	SU.311	BPW-034	SU.400	BPW-095
WI0982	BPW-124	SU.217	BPW-014	SU.312	BPW-011	SU.406	BPW-309
WI0983	BPW-135	SU.218	BPW-021	SU.313	BPW-004	SU.412	BPW-304
WI0984	BPW-095	SU.219	BPW-177	SU.314	BPW-018	SU.413	BPW-303
WI0985	BPW-106	SU.220	BPW-060	SU.315	BPW-035		
WI0986	BPW-087	SU.220	BPW-158	SU.316	BPW-080		
		SU.221	BPW-058	SU.317	BPW-032		

N.B.: I CODICI O.E. ED IL LORO TESTO SONO RIPORTATI SOLO A TITOLO INDICATIVO
THE O.E. CODES AND THEIR TEXT ARE REPORTED ONLY FOR INDICATIVE PURPOSE

DELPHI	CODICE (CODE)	DELPHI	CODICE (CODE)	FEBI	CODICE (CODE)	FEBI	CODICE (CODE)
BAV1024	BPW-107	LZ0276	BPW-015	02398	BPW-178	30613	BPW-045
LZ0008	BPW-119	LZ0314	BPW-073	02917	BPW-307	31011	BPW-184
LZ0010	BPW-217	LZ0318	BPW-070	02918	BPW-293	31562	BPW-086
LZ0013	BPW-252	LZ0330	BPW-007	05109	BPW-292	31563	BPW-077
LZ0108	BPW-119	LZ0342	BPW-134	05110	BPW-252	31820	BPW-143
LZ0109	BPW-178	LZ0350	BPW-095	06860	BPW-126	31821	BPW-099
LZ0113	BPW-252	LZ0357	BPW-169	06867	BPW-203	31822	BPW-109
LZ0119	BPW-203	LZ0361	BPW-185	07736	BPW-119	31823	BPW-047
LZ0140	BPW-191	LZ0375	BPW-138	07835	BPW-012	33406	BPW-265
LZ0152	BPW-162			07849	BPW-191	33408	BPW-177
LZ0153	BPW-003			07880	BPW-054	33410	BPW-164
LZ0162	BPW-002			08045	BPW-217	34497	BPW-042
LZ0178	BPW-205			08197	BPW-111	34498	BPW-027
LZ0182	BPW-227			08203	BPW-085	34499	BPW-036
LZ0185	BPW-007			11935	BPW-040	35447	BPW-289
LZ0188	BPW-141			11936	BPW-039	35448	BPW-311
LZ0190	BPW-004			11941	BPW-180	35450	BPW-290
LZ0192	BPW-062			15049	BPW-288	35493	BPW-285
LZ0194	BPW-047			17204	BPW-175	36426	BPW-013
LZ0196	BPW-109			17489	BPW-162	36427	BPW-082
LZ0198	BPW-099			17952	BPW-131	36428	BPW-108
LZ0199	BPW-018			17967	BPW-248	36429	BPW-016
LZ0205	BPW-193			18559	BPW-078	36570	BPW-068
LZ0207	BPW-158			18560	BPW-071	36571	BPW-065
LZ0211	BPW-013			19186	BPW-003	37158	BPW-044
LZ0212	BPW-108			21072	BPW-206	37256	BPW-038
LZ0213	BPW-082			22072	BPW-226	37437	BPW-029
LZ0215	BPW-079			22396	BPW-090	37454	BPW-181
LZ0216	BPW-144			22397	BPW-096	37458	BPW-198
LZ0217	BPW-056			22577	BPW-107	37662	BPW-076
LZ0218	BPW-038			22577	BPW-154	37664	BPW-088
LZ0219	BPW-134			22663	BPW-001	37665	BPW-062
LZ0222	BPW-198			23021	BPW-043	37667	BPW-056
LZ0223	BPW-232			23025	BPW-055	37668	BPW-079
LZ0224	BPW-181			23121	BPW-112	37669	BPW-063
LZ0230	BPW-107			23123	BPW-113	37727	BPW-030
LZ0232	BPW-154			23360	BPW-014	37728	BPW-067
LZ0235	BPW-029			23362	BPW-021	38173	BPW-232
LZ0236	BPW-030			23857	BPW-002	38174	BPW-059
LZ0237	BPW-016			23908	BPW-117	38578	BPW-144
LZ0238	BPW-114			23951	BPW-081	38642	BPW-205
LZ0239	BPW-008			24012	BPW-084	39138	BPW-008
LZ0240	BPW-010			24013	BPW-227	39139	BPW-010
LZ0241	BPW-067			24319	BPW-028	39141	BPW-114
LZ0242	BPW-059			24320	BPW-037	39246	BPW-005
LZ0243	BPW-068			24505	BPW-246	39247	BPW-019
LZ0244	BPW-065			26370	BPW-295	43485	BPW-006
LZ0247	BPW-044			27183	BPW-141	44358	BPW-178
LZ0248	BPW-036			28139	BPW-007	44479	BPW-312
LZ0249	BPW-027			29414	BPW-004	45231	BPW-300
LZ0250	BPW-300			29546	BPW-018	45232	BPW-149
LZ0252	BPW-305			29661	BPW-058	47367	BPW-101
LZ0254	BPW-179			29662	BPW-128	47368	BPW-092
LZ0256	BPW-290			30611	BPW-158	47371	BPW-080
LZ0264	BPW-265			30612	BPW-060	47372	BPW-032

N.B.: I CODICI O.E. ED IL LORO TESTO SONO RIPORTATI SOLO A TITOLO INDICATIVO
THE O.E. CODES AND THEIR TEXT ARE REPORTED ONLY FOR INDICATIVE PURPOSE

FEBI	CODICE (CODE)	FERODO	CODICE (CODE)	FERODO	CODICE (CODE)	FERODO	CODICE (CODE)
47373	BPW-035	FAI102	BPW-025	FWI274	BPW-021	FWI361	BPW-088
47375	BPW-305	FAI106	BPW-294	FWI275	BPW-113	FWI362	BPW-062
100352	BPW-025	FAI115	BPW-288	FWI276	BPW-112	FWI363	BPW-056
100996	BPW-297	FAI119	BPW-294	FWI277	BPW-055	FWI365	BPW-067
100997	BPW-291	FWI201	BPW-119	FWI278	BPW-061	FWI366	BPW-154
101071	BPW-034	FWI202	BPW-178	FWI279	BPW-132	FWI371	BPW-043
101072	BPW-015	FWI204	BPW-217	FWI280	BPW-204	FWI372	BPW-045
102261	BPW-287	FWI205	BPW-126	FWI282	BPW-047	FWI374	BPW-082
102262	BPW-011	FWI206	BPW-025	FWI283	BPW-131	FWI375	BPW-108
104575	BPW-022	FWI207	BPW-054	FWI285	BPW-248	FWI376	BPW-038
104576	BPW-026	FWI208	BPW-301	FWI286	BPW-227	FWI377	BPW-059
104599	BPW-134	FWI209	BPW-252	FWI289	BPW-141	FWI391	BPW-184
104918	BPW-070	FWI211	BPW-292	FWI289	BPW-149	FWI398	BPW-305
104919	BPW-041	FWI212	BPW-302	FWI291	BPW-117	FWI399	BPW-179
104919	BPW-313	FWI213	BPW-178	FWI292	BPW-081	FWI401	BPW-068
104920	BPW-314	FWI223	BPW-301	FWI293	BPW-018	FWI402	BPW-065
106209	BPW-286	FWI226	BPW-025	FWI294	BPW-004	FWI406	BPW-027
170746	BPW-053	FWI226/1	BPW-025	FWI295	BPW-040	FWI407	BPW-149
170747	BPW-049	FWI226/4	BPW-025	FWI296	BPW-001	FWI408	BPW-098
170748	BPW-031	FWI227	BPW-025	FWI297	BPW-186	FWI410	BPW-019
170793	BPW-050	FWI232	BPW-126	FWI297	BPW-186	FWI411	BPW-008
171446	BPW-057	FWI232	BPW-203	FWI298	BPW-099	FWI412	BPW-016
171448	BPW-074	FWI233	BPW-119	FWI299	BPW-290	FWI413	BPW-205
172460	BPW-296	FWI233	BPW-119	FWI300	BPW-246	FWI414	BPW-144
172511	BPW-129	FWI236	BPW-178	FWI301	BPW-084	FWI414	BPW-144
172593	BPW-073	FWI242	BPW-307	FWI303	BPW-285	FWI415	BPW-030
172595	BPW-127	FWI243	BPW-175	FWI304	BPW-286	FWI416	BPW-036
172598	BPW-083	FWI246	BPW-012	FWI305	BPW-286	FWI418	BPW-029
172607	BPW-100	FWI250	BPW-180	FWI306	BPW-289	FWI419	BPW-185
173560	BPW-299	FWI251	BPW-293	FWI308	BPW-295	FWI421	BPW-287
173568	BPW-298	FWI252	BPW-085	FWI309	BPW-077	FWI422	BPW-297
176452	BPW-124	FWI253	BPW-111	FWI310	BPW-296	FWI423	BPW-291
179227	BPW-135	FWI255	BPW-164	FWI311	BPW-007	FWI435	BPW-114
180131	BPW-091	FWI256	BPW-177	FWI314	BPW-306	FWI436	BPW-010
197401	BPW-309	FWI257	BPW-162	FWI315	BPW-109	FWI438	BPW-034
		FWI258	BPW-039	FWI316	BPW-086	FWI442	BPW-059
		FWI259	BPW-040	FWI317	BPW-158	FWI443	BPW-015
		FWI260	BPW-206	FWI318	BPW-060	FWI444	BPW-014
		FWI261	BPW-003	FWI320	BPW-045	FWI448	BPW-016
		FWI261	BPW-005	FWI321	BPW-058	FWI448	BPW-026
		FWI261/1	BPW-002	FWI328	BPW-117	FWI449	BPW-011
		FWI2611	BPW-003	FWI331	BPW-128	FWI451	BPW-098
		FWI262	BPW-191	FWI332	BPW-077	FWI452	BPW-041
		FWI263	BPW-043	FWI333	BPW-232	FWI452	BPW-313
		FWI264	BPW-078	FWI334	BPW-013	FWI453	BPW-083
		FWI265	BPW-071	FWI335	BPW-038	FWI454	BPW-101
		FWI266	BPW-002	FWI345	BPW-265	FWI457	BPW-080
		FWI2661	BPW-002	FWI347	BPW-193	FWI458	BPW-032
		FWI267	BPW-107	FWI350	BPW-143	FWI459	BPW-035
		FWI267	BPW-154	FWI353	BPW-198	FWI460	BPW-050
		FWI268	BPW-028	FWI354	BPW-134	FWI463	BPW-031
		FWI269	BPW-037	FWI355	BPW-044	FWI464	BPW-127
		FWI270	BPW-096	FWI356	BPW-181	FWI465	BPW-129
		FWI271	BPW-090	FWI357	BPW-063		
		FWI272	BPW-226	FWI358	BPW-076		
		FWI273	BPW-014	FWI359	BPW-079		

N.B.: I CODICI O.E. ED IL LORO TESTO SONO RIPORTATI SOLO A TITOLO INDICATIVO
THE O.E. CODES AND THEIR TEXT ARE REPORTED ONLY FOR INDICATIVE PURPOSE

FRI.TECH.	CODICE (CODE)	FRI.TECH.	CODICE (CODE)	FRI.TECH.	CODICE (CODE)	FTE	CODICE (CODE)
SU.012	BPW-054	SU.221	BPW-134	SU.318	BPW-162	BZ1002W	BPW-217
SU.093	BPW-293	SU.222	BPW-086	SU.319	BPW-246	BZ1006W	BPW-119
SU.011	BPW-025	SU.223	BPW-077	SU.320	BPW-141	BZ1015W	BPW-252
SU.072	BPW-217	SU.224	BPW-006	SU.321	BPW-179	BZ1026W	BPW-203
SU.082	BPW-252	SU.225K	BPW-285	SU.322	BPW-305	BZ1028W	BPW-178
SU.083	BPW-126	SU.226K	BPW-289	SU.324	BPW-067	BZ1032W	BPW-191
SU.083	BPW-203	SU.227K	BPW-290	SU.325	BPW-059	BZ1047W	BPW-119
SU.088	BPW-306	SU.229	BPW-047	SU.329	BPW-287	BZ1072W	BPW-003
SU.090	BPW-301	SU.242	BPW-296	SU.330	BPW-019	BZ1072WSET	BPW-003
SU.091	BPW-302	SU.246	BPW-184	SU.331	BPW-092	BZ1075W	BPW-002
SU.092	BPW-111	SU.253	BPW-143	SU.332	BPW-101	BZ1084W	BPW-177
SU.099	BPW-012	SU.255	BPW-099	SU.338	BPW-015	BZ1087W	BPW-164
SU.100K	BPW-288	SU.256	BPW-186	SU.340	BPW-297	BZ1087WSET	BPW-164
SU.101K	BPW-294	SU.259	BPW-128	SU.341	BPW-291	BZ1099W	BPW-001
SU.104	BPW-085	SU.260K	BPW-311	SU.345	BPW-083	BZ1124W	BPW-109
SU.108	BPW-292	SU.264	BPW-265	SU.346	BPW-313	BZ1124WSET	BPW-109
SU.112	BPW-039	SU.265	BPW-164	SU.347	BPW-031	BZ1131WSET	BPW-107
SU.113	BPW-040	SU.271	BPW-036	SU.348	BPW-041	BZ1135W	BPW-007
SU.123	BPW-248	SU.274	BPW-027	SU.349	BPW-310	BZ1153WSET	BPW-060
SU.129	BPW-002	SU.275	BPW-108	SU.350	BPW-022	BZ1154WSET	BPW-158
SU.129	BPW-005	SU.276	BPW-082	SU.351	BPW-026	BZ1161WSET	BPW-063
SU.129	BPW-003	SU.278	BPW-008	SU.352	BPW-070	BZ1167WSET	BPW-134
SU.142	BPW-180	SU.279	BPW-010	SU.353	BPW-050	BZ1174WSET	BPW-082
SU.143	BPW-307	SU.280	BPW-029	SU.357	BPW-130	BZ1188W	BPW-265
SU.144	BPW-175	SU.281	BPW-065	SU.361	BPW-049	BZ1188WSET	BPW-265
SU.145	BPW-226	SU.282	BPW-068	SU.362	BPW-053	BZ1192W	BPW-005
SU.147	BPW-131	SU.284	BPW-013	SU.364	BPW-127		
SU.148	BPW-206	SU.287	BPW-016	SU.365	BPW-129		
SU.149	BPW-096	SU.288	BPW-030	SU.366	BPW-124		
SU.150	BPW-043	SU.289	BPW-312	SU.368	BPW-114		
SU.151	BPW-112	SU.290	BPW-051	SU.372	BPW-299		
SU.152	BPW-078	SU.291	BPW-300	SU.373	BPW-074		
SU.153	BPW-132	SU.294	BPW-193	SU.374	BPW-057		
SU.155	BPW-071	SU.295	BPW-098	SU.376	BPW-138		
SU.156	BPW-204	SU.296	BPW-227	SU.377	BPW-102		
SU.157	BPW-055	SU.297	BPW-205	SU.379	BPW-298		
SU.158	BPW-113	SU.298	BPW-079	SU.380	BPW-314		
SU.161	BPW-107	SU.299	BPW-062	SU.383	BPW-091		
SU.161	BPW-154	SU.300	BPW-144	SU.384	BPW-139		
SU.164	BPW-001	SU.301	BPW-056	SU.385	BPW-100		
SU.164	BPW-007	SU.302	BPW-088	SU.387	BPW-135		
SU.189	BPW-090	SU.303	BPW-063	SU.388	BPW-087		
SU.195	BPW-081	SU.304	BPW-076	SU.389	BPW-106		
SU.196	BPW-084	SU.305	BPW-045	SU.390	BPW-105		
SU.204K	BPW-286	SU.307	BPW-198	SU.391	BPW-165		
SU.205	BPW-037	SU.308	BPW-181	SU.392	BPW-073		
SU.206	BPW-028	SU.309	BPW-038	SU.396	BPW-308		
SU.207	BPW-117	SU.310	BPW-044	SU.398	BPW-295		
SU.209	BPW-061	SU.311	BPW-034	SU.400	BPW-095		
SU.217	BPW-014	SU.312	BPW-011	SU.406	BPW-309		
SU.218	BPW-021	SU.313	BPW-004	SU.412	BPW-304		
SU.219	BPW-177	SU.314	BPW-018	SU.413	BPW-303		
SU.220	BPW-060	SU.315	BPW-035				
SU.220	BPW-158	SU.316	BPW-080				
SU.221	BPW-058	SU.317	BPW-032				

N.B.: I CODICI O.E. ED IL LORO TESTO SONO RIPORTATI SOLO A TITOLO INDICATIVO
THE O.E. CODES AND THEIR TEXT ARE REPORTED ONLY FOR INDICATIVE PURPOSE

GALFER	CODICE (CODE)	GALFER	CODICE (CODE)	GIRLING	CODICE (CODE)	HELLA	CODICE (CODE)
25002	BPW-126	B1G19000452	BPW-154	6310902	BPW-178	8DA35505076	BPW-007
25008	BPW-085	B1G19000472	BPW-252	6311002	BPW-178	8DB35503686	BPW-007
25009	BPW-039	B1G19000552	BPW-177	6311202	BPW-203	8DD35511764	BPW-007
25010	BPW-126	B1G19000652	BPW-158	6320009	BPW-154	8DD35513183	BPW-007
25012	BPW-126	B1G19000752	BPW-060	6320209	BPW-107	8DK35525000	BPW-217
25013	BPW-111	B1G19000932	BPW-007	6322804	BPW-001	8DK35525001	BPW-054
25014	BPW-040	B1G19001202	BPW-005	6323702	BPW-060	8DK35525003	BPW-119
25015	BPW-206	B1G19001262	BPW-001	6323802	BPW-158	8DK35525006	BPW-178
25016	BPW-131	B1G19001382	BPW-092	6324201	BPW-005	8DK35525009	BPW-252
25017	BPW-071	B1G19001552	BPW-169	6325304	BPW-007	8DK35525013	BPW-301
25018	BPW-078	B1G19001792	BPW-138	6326501	BPW-134	8DK35525014	BPW-025
25021	BPW-040	G1900007	BPW-003	6331702	BPW-265	8DK35525015	BPW-025
25022	BPW-084	G1900017	BPW-217	6336402	BPW-185	8DK35525016	BPW-203
25024	BPW-112	G1900042	BPW-002	6336501	BPW-149	8DK35525017	BPW-126
25025	BPW-113	G1900047	BPW-252	6337202	BPW-305	8DK35525018	BPW-292
25026	BPW-028	G1900055	BPW-177			8DK35525020	BPW-191
25027	BPW-037	G1900138	BPW-092			8DK35525021	BPW-307
25028	BPW-055	G1900179	BPW-138			8DK35525022	BPW-175
25029	BPW-043					8DK35525025	BPW-180
25030	BPW-025					8DK35525026	BPW-293
25031	BPW-054					8DK35525027	BPW-085
25036	BPW-012					8DK35525028	BPW-111
25038	BPW-061					8DK35525029	BPW-126
25056	BPW-292					8DK35525030	BPW-012
25060	BPW-175					8DK35525033	BPW-164
25063	BPW-180					8DK35525034	BPW-177
25064	BPW-293					8DK35525036	BPW-039
25067	BPW-226					8DK35525037	BPW-040
25150	BPW-288					8DK35525038	BPW-003
25151	BPW-294					8DK35525039	BPW-206
25162	BPW-248					8DK35525043	BPW-248
25166	BPW-132					8DK35525044	BPW-078
25167	BPW-204					8DK35525045	BPW-071
25170	BPW-096					8DK35525046	BPW-131
25171	BPW-077					8DK35525048	BPW-154
900003	BPW-028					8DK35525050	BPW-040
900016	BPW-288					8DK35525051	BPW-226
900032	BPW-081					8DK35525052	BPW-112
900085	BPW-065					8DK35525053	BPW-113
900088	BPW-006					8DK35525054	BPW-002
900089	BPW-029					8DK35525055	BPW-184
900090	BPW-030					8DK35525058	BPW-246
900109	BPW-008					8DK35525059	BPW-227
900110	BPW-098					8DK35525060	BPW-107
900113	BPW-010					8DK35525062	BPW-096
900124	BPW-034					8DK35525063	BPW-090
900125	BPW-011					8DK35525064	BPW-043
B1G19000742	BPW-295					8DK35525065	BPW-055
B1G19001182	BPW-114					8DK35525066	BPW-081
B1G19000072	BPW-003					8DK35525067	BPW-084
B1G19000172	BPW-217					8DK35525069	BPW-014
B1G19000222	BPW-178					8DK35525070	BPW-021
B1G19000252	BPW-203					8DK35525071	BPW-117
B1G19000422	BPW-002					8DK35525072	BPW-037
B1G19000432	BPW-107					8DK35525073	BPW-028

N.B.: I CODICI O.E. ED IL LORO TESTO SONO RIPORTATI SOLO A TITOLO INDICATIVO
THE O.E. CODES AND THEIR TEXT ARE REPORTED ONLY FOR INDICATIVE PURPOSE

ICER	CODICE (CODE)	ICER	CODICE (CODE)	JURID	CODICE (CODE)	LPR	CODICE (CODE)
610056EC	BPW-025	610504EC	BPW-141	581300J	BPW-119	KS0002	BPW-021
610057EC	BPW-054	610507EC	BPW-051	581301J	BPW-217	KS0004	BPW-014
610069EC	BPW-302	610508EC	BPW-300	581303J	BPW-178	KS0005	BPW-184
610239EC	BPW-178	610535EC	BPW-246	581306D	BPW-025	KS0006	BPW-028
610240EC	BPW-126	610536EC	BPW-132	581306J	BPW-025	KS0007	BPW-037
610240EC	BPW-203	610538EC	BPW-045	581329J	BPW-178	KS0010	BPW-040
610241EC	BPW-292	610540EC	BPW-068	581330J	BPW-203	KS0012	BPW-131
610242EC	BPW-126	610541EC	BPW-065	581337J	BPW-252	KS0013	BPW-128
610255EC	BPW-294	610542EC	BPW-063	581349J	BPW-164	KS0014	BPW-045
610256EC	BPW-288	610544EC	BPW-098	581361J	BPW-107	KS0015	BPW-126
610259EC	BPW-012	610545EC	BPW-149	581362J	BPW-177	KS0018	BPW-126
610323EC	BPW-003	610547EC	BPW-027	581366J	BPW-191	KS0019	BPW-217
610323EC	BPW-005	610548EC	BPW-019	581368J	BPW-154	KS0020	BPW-126
610370EC	BPW-001	610550EC	BPW-143	581379J	BPW-003	KS0020	BPW-203
610377EC	BPW-061	610552EC	BPW-158	581383J	BPW-002	KS0021	BPW-040
610388EC	BPW-111	610553EC	BPW-060	581385J	BPW-141	KS0022	BPW-039
610390EC	BPW-039	610555EC	BPW-134	581402J	BPW-060	KS0024	BPW-043
610391EC	BPW-040	610556EC	BPW-029	581404J	BPW-001	KS0025	BPW-117
610394EC	BPW-178	610557EC	BPW-016	581415J	BPW-158	KS0027	BPW-206
610398EC	BPW-154	610558EC	BPW-013	581417J	BPW-044	KS0028	BPW-055
610425EC	BPW-126	610559EC	BPW-030	581441J	BPW-295	KS0029	BPW-178
610426EC	BPW-126	610560EC	BPW-010	581451J	BPW-038	KS0030	BPW-085
610444EC	BPW-162	610561EC	BPW-008	581452J	BPW-134	KS0031	BPW-111
610445EC	BPW-292	610571EC	BPW-032	581462J	BPW-051	KS0038	BPW-113
610446EC	BPW-175	610576EC	BPW-287	581463J	BPW-149	KS0039	BPW-112
610447EC	BPW-180	610603EC	BPW-081	581481J	BPW-181	KS0043	BPW-084
610448EC	BPW-248	610605EC	BPW-077	581483J	BPW-082	KS0044	BPW-081
610451EC	BPW-293	610606EC	BPW-079	581501J	BPW-185	KS0046	BPW-078
610452EC	BPW-226	610607EC	BPW-056	581508J	BPW-265	KS0047	BPW-071
610454EC	BPW-107	610612EC	BPW-295	581511J	BPW-005	KS0048	BPW-058
610456EC	BPW-306	610616EC	BPW-099	587002D	BPW-294	KS0049	BPW-060
610457EC	BPW-206	610619EC	BPW-305	587002J	BPW-294	KS0050	BPW-158
610458EC	BPW-085	610621EC	BPW-038	587010D	BPW-012	KS0051	BPW-227
610468EC	BPW-286	610623EC	BPW-134	587010J	BPW-012	KS0057	BPW-047
610469EC	BPW-285			587024D	BPW-288	KS0059	BPW-186
610471EC	BPW-289			587024J	BPW-288	KS0060	BPW-025
610474EC	BPW-037			587025D	BPW-294	KS0061	BPW-054
610475EC	BPW-028			587025J	BPW-294	KS0062	BPW-002
610476EC	BPW-014			587047J	BPW-004	KS0063	BPW-295
610477EC	BPW-021			587048J	BPW-018	KS0065	BPW-002
610478EC	BPW-043					KS0067	BPW-001
610479EC	BPW-055					KS0068	BPW-154
610480EC	BPW-117					KS0069	BPW-107
610482EC	BPW-047					KS0070	BPW-007
610483EC	BPW-004					KS0071	BPW-012
610484EC	BPW-018					KS0072	BPW-004
610496EC	BPW-296					KS0074	BPW-248
610497EC	BPW-039					KS0076	BPW-096
610497EC	BPW-131					KS0077	BPW-090
610498EC	BPW-071					KS0078	BPW-086
610499EC	BPW-078					KS0079	BPW-077
610500EC	BPW-096					KS0080	BPW-162
610501EC	BPW-090					KS0081	BPW-141
610502EC	BPW-113					KS0082	BPW-292
610503EC	BPW-112					KS0083	BPW-252

N.B.: I CODICI O.E. ED IL LORO TESTO SONO RIPORTATI SOLO A TITOLO INDICATIVO
THE O.E. CODES AND THEIR TEXT ARE REPORTED ONLY FOR INDICATIVE PURPOSE

LPR	CODICE (CODE)	LPR	CODICE (CODE)	METELLI	CODICE (CODE)	METELLI	CODICE (CODE)
KS0086	BPW-302	KS0220	BPW-193	SU.012	BPW-054	SU.221	BPW-134
KS0088	BPW-175	KS0233	BPW-149	SU.093	BPW-293	SU.222	BPW-086
KS0089	BPW-301	KS0234	BPW-185	SU.011	BPW-025	SU.223	BPW-077
KS0091	BPW-307	KS0236	BPW-300	SU.072	BPW-217	SU.224	BPW-006
KS0096	BPW-226	KS0238	BPW-011	SU.082	BPW-252	SU.225K	BPW-285
KS0098	BPW-180	KS0241	BPW-005	SU.083	BPW-126	SU.226K	BPW-289
KS0099	BPW-293	KS0242	BPW-034	SU.083	BPW-203	SU.227K	BPW-290
KS0100	BPW-301	KS0249	BPW-035	SU.088	BPW-306	SU.229	BPW-047
KS0105	BPW-177	KS0265	BPW-022	SU.090	BPW-301	SU.242	BPW-296
KS0127	BPW-288	KS0266	BPW-026	SU.091	BPW-302	SU.246	BPW-184
KS0136	BPW-025	KS0268	BPW-015	SU.092	BPW-111	SU.253	BPW-143
KS0137	BPW-025	KS0271	BPW-049	SU.099	BPW-012	SU.255	BPW-099
KS0139	BPW-295	KS0284	BPW-087	SU.100K	BPW-288	SU.256	BPW-186
KS0144	BPW-036	KS0285	BPW-057	SU.101K	BPW-294	SU.259	BPW-128
KS0145	BPW-289			SU.104	BPW-085	SU.260K	BPW-311
KS0147	BPW-294			SU.108	BPW-292	SU.264	BPW-265
KS0149	BPW-290			SU.112	BPW-039	SU.265	BPW-164
KS0151	BPW-296			SU.113	BPW-040	SU.271	BPW-036
KS0153	BPW-076			SU.123	BPW-248	SU.274	BPW-027
KS0154	BPW-088			SU.129	BPW-002	SU.275	BPW-108
KS0155	BPW-062			SU.129	BPW-005	SU.276	BPW-082
KS0156	BPW-063			SU.129	BPW-003	SU.278	BPW-008
KS0157	BPW-056			SU.142	BPW-180	SU.279	BPW-010
KS0158	BPW-134			SU.143	BPW-307	SU.280	BPW-029
KS0160	BPW-016			SU.144	BPW-175	SU.281	BPW-065
KS0161	BPW-082			SU.145	BPW-226	SU.282	BPW-068
KS0162	BPW-013			SU.147	BPW-131	SU.284	BPW-013
KS0164	BPW-044			SU.148	BPW-206	SU.287	BPW-016
KS0165	BPW-108			SU.149	BPW-096	SU.288	BPW-030
KS0167	BPW-198			SU.150	BPW-043	SU.289	BPW-312
KS0168	BPW-067			SU.151	BPW-112	SU.290	BPW-051
KS0169	BPW-059			SU.152	BPW-078	SU.291	BPW-300
KS0171	BPW-099			SU.153	BPW-132	SU.294	BPW-193
KS0172	BPW-143			SU.155	BPW-071	SU.295	BPW-098
KS0173	BPW-006			SU.156	BPW-204	SU.296	BPW-227
KS0176	BPW-030			SU.157	BPW-055	SU.297	BPW-205
KS0177	BPW-008			SU.158	BPW-113	SU.298	BPW-079
KS0178	BPW-010			SU.161	BPW-107	SU.299	BPW-062
KS0183	BPW-018			SU.161	BPW-154	SU.300	BPW-144
KS0184	BPW-312			SU.164	BPW-001	SU.301	BPW-056
KS0188	BPW-027			SU.164	BPW-007	SU.302	BPW-088
KS0190	BPW-038			SU.189	BPW-090	SU.303	BPW-063
KS0191	BPW-079			SU.195	BPW-081	SU.304	BPW-076
KS0192	BPW-144			SU.196	BPW-084	SU.305	BPW-045
KS0193	BPW-068			SU.204K	BPW-286	SU.307	BPW-198
KS0194	BPW-065			SU.205	BPW-037	SU.308	BPW-181
KS0195	BPW-029			SU.206	BPW-028	SU.309	BPW-038
KS0196	BPW-114			SU.207	BPW-117	SU.310	BPW-044
KS0198	BPW-205			SU.209	BPW-061	SU.311	BPW-034
KS0201	BPW-132			SU.217	BPW-014	SU.312	BPW-011
KS0202	BPW-204			SU.218	BPW-021	SU.313	BPW-004
KS0206	BPW-080			SU.219	BPW-177	SU.314	BPW-018
KS0207	BPW-032			SU.220	BPW-060	SU.315	BPW-035
KS0209	BPW-305			SU.220	BPW-158	SU.316	BPW-080
KS0211	BPW-179			SU.221	BPW-058	SU.317	BPW-032

N.B.: I CODICI O.E. ED IL LORO TESTO SONO RIPORTATI SOLO A TITOLO INDICATIVO
THE O.E. CODES AND THEIR TEXT ARE REPORTED ONLY FOR INDICATIVE PURPOSE

METELLI	CODICE (CODE)	MINTEX	CODICE (CODE)	MINTEX	CODICE (CODE)	MINTEX	CODICE (CODE)
SU.318	BPW-162	MWI0103	BPW-217	MWI0247	BPW-028	MWI0524	BPW-032
SU.319	BPW-246	MWI0104	BPW-119	MWI0248	BPW-227	MWI0525	BPW-305
SU.320	BPW-141	MWI0105	BPW-126	MWI0249	BPW-117	MWI0528	BPW-005
SU.321	BPW-179	MWI0106	BPW-126	MWI0250	BPW-037	MWI0529	BPW-149
SU.322	BPW-305	MWI0106	BPW-203	MWI0251	BPW-061	MWI0531	BPW-051
SU.324	BPW-067	MWI0107	BPW-178	MWI0253	BPW-132	MWI0533	BPW-179
SU.325	BPW-059	MWI0110	BPW-306	MWI0254	BPW-204	MWI0534	BPW-149
SU.329	BPW-287	MWI0111	BPW-054	MWI0259	BPW-128	MWI0540	BPW-206
SU.330	BPW-019	MWI0115	BPW-025	MWI0263	BPW-109	MWI0542	BPW-098
SU.331	BPW-092	MWI0119	BPW-292	MWI0265	BPW-099	MWI0543	BPW-019
SU.332	BPW-101	MWI0121	BPW-302	MWI0266	BPW-018	MWI0545	BPW-295
SU.338	BPW-015	MWI0123	BPW-301	MWI0403	BPW-060	MWI0547	BPW-164
SU.340	BPW-297	MWI0124	BPW-252	MWI0404	BPW-158	MWI0551	BPW-185
SU.341	BPW-291	MWI0125	BPW-302	MWI0407	BPW-043	MWI0554	BPW-035
SU.345	BPW-083	MWI0126	BPW-175	MWI0416	BPW-186	MWI0555	BPW-101
SU.346	BPW-313	MWI0129	BPW-301	MWI0446	BPW-265	MWI0559	BPW-092
SU.347	BPW-031	MWI0154	BPW-191	MWI0450	BPW-193	MWI0568	BPW-015
SU.348	BPW-041	MWI0157	BPW-175	MWI0453	BPW-001	MWI0574	BPW-070
SU.349	BPW-310	MWI0158	BPW-307	MWI0456	BPW-285	MWI0575	BPW-050
SU.350	BPW-022	MWI0163	BPW-085	MWI0458	BPW-290	MWI0577	BPW-137
SU.351	BPW-026	MWI0164	BPW-111	MWI0466	BPW-289	MWI0578	BPW-178
SU.352	BPW-070	MWI0165	BPW-180	MWI0467	BPW-014	MWI0592	BPW-053
SU.353	BPW-050	MWI0166	BPW-293	MWI0468	BPW-013	MWI0593	BPW-049
SU.357	BPW-130	MWI0168	BPW-012	MWI0469	BPW-082	MWI0604	BPW-169
SU.361	BPW-049	MWI0171	BPW-025	MWI0472	BPW-205	MWI0612	BPW-129
SU.362	BPW-053	MWI0172	BPW-025	MWI0473	BPW-144	MWI0613	BPW-127
SU.364	BPW-127	MWI0173	BPW-025	MWI0476	BPW-108	MWI0628	BPW-073
SU.365	BPW-129	MWI0179	BPW-288	MWI0477	BPW-016		
SU.366	BPW-124	MWI0191	BPW-039	MWI0478	BPW-134		
SU.368	BPW-114	MWI0192	BPW-040	MWI0479	BPW-029		
SU.372	BPW-299	MWI0196	BPW-003	MWI0480	BPW-044		
SU.373	BPW-074	MWI0197	BPW-248	MWI0481	BPW-076		
SU.374	BPW-057	MWI0199	BPW-131	MWI0482	BPW-088		
SU.376	BPW-138	MWI0200	BPW-071	MWI0483	BPW-063		
SU.377	BPW-102	MWI0201	BPW-078	MWI0484	BPW-079		
SU.379	BPW-298	MWI0207	BPW-154	MWI0486	BPW-181		
SU.380	BPW-314	MWI0209	BPW-154	MWI0487	BPW-062		
SU.383	BPW-091	MWI0212	BPW-107	MWI0488	BPW-038		
SU.384	BPW-139	MWI0213	BPW-002	MWI0490	BPW-068		
SU.385	BPW-100	MWI0214	BPW-002	MWI0491	BPW-065		
SU.387	BPW-135	MWI0216	BPW-096	MWI0492	BPW-067		
SU.388	BPW-087	MWI0217	BPW-090	MWI0493	BPW-059		
SU.389	BPW-106	MWI0218	BPW-043	MWI0497	BPW-042		
SU.390	BPW-105	MWI0219	BPW-055	MWI0498	BPW-027		
SU.391	BPW-165	MWI0220	BPW-226	MWI0499	BPW-036		
SU.392	BPW-073	MWI0222	BPW-113	MWI0501	BPW-246		
SU.396	BPW-308	MWI0224	BPW-112	MWI0502	BPW-045		
SU.398	BPW-295	MWI0225	BPW-014	MWI0504	BPW-030		
SU.400	BPW-095	MWI0226	BPW-021	MWI0506	BPW-054		
SU.406	BPW-309	MWI0227	BPW-004	MWI0507	BPW-198		
SU.412	BPW-304	MWI0229	BPW-007	MWI0509	BPW-300		
SU.413	BPW-303	MWI0230	BPW-184	MWI0514	BPW-114		
		MWI0242	BPW-295	MWI0516	BPW-008		
		MWI0244	BPW-081	MWI0517	BPW-010		
		MWI0246	BPW-084	MWI0523	BPW-080		

N.B.: I CODICI O.E. ED IL LORO TESTO SONO RIPORTATI SOLO A TITOLO INDICATIVO
THE O.E. CODES AND THEIR TEXT ARE REPORTED ONLY FOR INDICATIVE PURPOSE

NK	CODICE (CODE)	NK	CODICE (CODE)	OPENPARTS	CODICE (CODE)	OPENPARTS	CODICE (CODE)
280006	BPW-119	284701	BPW-185	AK3004.00	BPW-126	AK3153.00	BPW-026
280008	BPW-178	284703	BPW-149	AK3010.00	BPW-054	AK3155.00	BPW-044
280009	BPW-217	890008	BPW-178	AK3015.00	BPW-292	AK3173.00	BPW-114
280024	BPW-252	890027	BPW-203	AK3053.00	BPW-175	AK3183.00	BPW-015
280027	BPW-203	890037	BPW-178	AK3054.00	BPW-307	AK3201.00	BPW-169
280037	BPW-178			AK3057.00	BPW-085		
280084	BPW-003			AK3058.00	BPW-111		
280097	BPW-154			AK3059.00	BPW-180		
280100	BPW-107			AK3060.00	BPW-293		
280101	BPW-002			AK3061.00	BPW-012		
280114	BPW-004			AK3064.00	BPW-025		
280114	BPW-007			AK3074.00	BPW-039		
280116	BPW-007			AK3075.00	BPW-040		
280117	BPW-184			AK3077.00	BPW-162		
280128	BPW-295			AK3079.00	BPW-248		
280138	BPW-018			AK3081.00	BPW-071		
280150	BPW-003			AK3082.00	BPW-078		
280153	BPW-227			AK3085.00	BPW-131		
280165	BPW-047			AK3086.00	BPW-206		
280172	BPW-060			AK3090.00	BPW-288		
280176	BPW-193			AK3095.00	BPW-096		
280182	BPW-134			AK3096.00	BPW-043		
280183	BPW-038			AK3098.00	BPW-226		
280184	BPW-082			AK3099.00	BPW-113		
280187	BPW-108			AK3100.00	BPW-112		
280188	BPW-013			AK3101.00	BPW-014		
280192	BPW-079			AK3102.00	BPW-021		
280193	BPW-198			AK3104.00	BPW-184		
280195	BPW-144			AK3107.00	BPW-090		
280196	BPW-181			AK3109.00	BPW-081		
280197	BPW-044			AK3110.00	BPW-084		
280198	BPW-067			AK3111.00	BPW-028		
280199	BPW-059			AK3113.00	BPW-117		
280202	BPW-029			AK3114.00	BPW-037		
280203	BPW-030			AK3117.00	BPW-132		
280204	BPW-016			AK3118.00	BPW-204		
280205	BPW-114			AK3119.00	BPW-141		
280207	BPW-065			AK3121.00	BPW-004		
280208	BPW-036			AK3122.00	BPW-128		
280209	BPW-027			AK3123.00	BPW-006		
280212	BPW-088			AK3123.00	BPW-083		
280213	BPW-008			AK3125.00	BPW-058		
280214	BPW-010			AK3127.00	BPW-047		
280217	BPW-076			AK3128.00	BPW-099		
280223	BPW-080			AK3130.00	BPW-086		
280231	BPW-015			AK3131.00	BPW-077		
280244	BPW-070			AK3133.00	BPW-285		
280245	BPW-073			AK3134.00	BPW-286		
280260	BPW-124			AK3135.00	BPW-018		
280261	BPW-049			AK3139.00	BPW-132		
280262	BPW-053			AK3145.00	BPW-067		
280264	BPW-100			AK3146.00	BPW-059		
280265	BPW-139			AK3147.00	BPW-027		
280266	BPW-091			AK3150.00	BPW-068		
280276	BPW-179			AK3151.00	BPW-065		

N.B.: I CODICI O.E. ED IL LORO TESTO SONO RIPORTATI SOLO A TITOLO INDICATIVO
 THE O.E. CODES AND THEIR TEXT ARE REPORTED ONLY FOR INDICATIVE PURPOSE

OPTIMAL	CODICE (CODE)	QUINTON	CODICE (CODE)	REMSA	CODICE (CODE)	REMSA	CODICE (CODE)
WKT50040K	BPW-178	BP5001	BPW-119	001001	BPW-054	001081	BPW-128
WKT50165K	BPW-178	BP5002	BPW-217	001002	BPW-025	001082	BPW-296
WKT50180K	BPW-203	BP5004	BPW-178	001006	BPW-302	001084	BPW-047
WKT50206K	BPW-178	BP5005	BPW-203	001009	BPW-012	001085	BPW-099
WKT50445K	BPW-154	BP5015	BPW-252	001010	BPW-292	001087	BPW-086
WKT50504K	BPW-107	BWI1020	BPW-162	001014	BPW-126	001088	BPW-077
WKT50581K	BPW-007	BWI1066	BPW-141	001015	BPW-126	001090	BPW-265
WKT50607K	BPW-001	BWI1071	BPW-164	001016	BPW-126	001092	BPW-288
WKT50642K	BPW-060	BWI1083	BPW-004	001016	BPW-203	001093	BPW-285
WKT50645K	BPW-158	BWI1090	BPW-295	001017	BPW-040	001094	BPW-286
WKT60027K	BPW-134	BWI1096	BPW-063	001018	BPW-039	001095	BPW-018
WKT60085K	BPW-185	BWI1100	BPW-114	001022	BPW-111	001096	BPW-001
WKT60089K	BPW-134	BWI1203	BPW-305	001023	BPW-206	001098	BPW-158
WKT60093K	BPW-005	BWI1205	BPW-179	001024	BPW-085	001101	BPW-088
		BWI1241	BPW-082	001026	BPW-306	001102	BPW-062
		BWI1257	BPW-051	001028	BPW-292	001103	BPW-056
		BZF5001	BPW-119	001029	BPW-175	001104	BPW-067
		BZF5002	BPW-217	001030	BPW-180	001105	BPW-059
		BZF5017	BPW-252	001032	BPW-248	001106	BPW-027
		BZF5028	BPW-191	001033	BPW-306	001108	BPW-036
				001036	BPW-293	001109	BPW-079
				001037	BPW-226	001111	BPW-205
				001039	BPW-003	001112	BPW-144
				001040	BPW-014	001113	BPW-068
				001041	BPW-021	001114	BPW-065
				001043	BPW-007	001115	BPW-134
				001046	BPW-307	001117	BPW-016
				001047	BPW-126	001118	BPW-013
				001048	BPW-071	001119	BPW-044
				001049	BPW-078	001120	BPW-029
				001050	BPW-131	001123	BPW-005
				001051	BPW-154	001129	BPW-063
				001052	BPW-040	001148	BPW-178
				001053	BPW-107	001151	BPW-164
				001054	BPW-096	001156	BPW-178
				001055	BPW-043	001190	BPW-169
				001056	BPW-055	001200	BPW-138
				001057	BPW-113		
				001058	BPW-112		
				001060	BPW-184		
				001063	BPW-090		
				001065	BPW-081		
				001066	BPW-084		
				001067	BPW-028		
				001068	BPW-227		
				001069	BPW-117		
				001070	BPW-037		
				001071	BPW-061		
				001073	BPW-132		
				001074	BPW-204		
				001075	BPW-141		
				001076	BPW-004		
				001077	BPW-006		
				001079	BPW-060		
				001080	BPW-058		

N.B.: I CODICI O.E. ED IL LORO TESTO SONO RIPORTATI SOLO A TITOLO INDICATIVO
THE O.E. CODES AND THEIR TEXT ARE REPORTED ONLY FOR INDICATIVE PURPOSE

TRUSTING	CODICE (CODE)	TRW	CODICE (CODE)	TRW	CODICE (CODE)	TRW	CODICE (CODE)
SU.318	BPW-162	GIC101	BPW-217	GIC200	BPW-154	GIC277	BPW-030
SU.319	BPW-246	GIC102	BPW-119	GIC202	BPW-107	GIC285	BPW-068
SU.320	BPW-141	GIC104	BPW-054	GIC202	BPW-154	GIC286	BPW-065
SU.321	BPW-179	GIC109	BPW-178	GIC203	BPW-004	GIC287	BPW-067
SU.322	BPW-305	GIC110	BPW-178	GIC204	BPW-081	GIC288	BPW-059
SU.324	BPW-067	GIC111	BPW-126	GIC205	BPW-289	GIC317	BPW-265
SU.325	BPW-059	GIC112	BPW-126	GIC206	BPW-084	GIC324	BPW-042
SU.329	BPW-287	GIC112	BPW-203	GIC207	BPW-028	GIC325	BPW-027
SU.330	BPW-019	GIC117	BPW-191	GIC208	BPW-227	GIC326	BPW-036
SU.331	BPW-092	GIC122	BPW-025	GIC209	BPW-117	GIC327	BPW-013
SU.332	BPW-101	GIC125	BPW-252	GIC210	BPW-037	GIC328	BPW-082
SU.338	BPW-015	GIC126	BPW-301	GIC210	BPW-076	GIC330	BPW-232
SU.340	BPW-297	GIC126	BPW-301	GIC213	BPW-132	GIC331	BPW-205
SU.341	BPW-291	GIC127	BPW-302	GIC214	BPW-204	GIC332	BPW-144
SU.345	BPW-083	GIC130	BPW-301	GIC215	BPW-141	GIC335	BPW-108
SU.346	BPW-313	GIC133	BPW-292	GIC215	BPW-149	GIC336	BPW-003
SU.347	BPW-031	GIC134	BPW-307	GIC216	BPW-128	GIC338	BPW-198
SU.348	BPW-041	GIC135	BPW-175	GIC218	BPW-047	GIC339	BPW-114
SU.349	BPW-310	GIC156	BPW-306	GIC220	BPW-109	GIC340	BPW-008
SU.350	BPW-022	GIC157	BPW-126	GIC221	BPW-186	GIC341	BPW-010
SU.351	BPW-026	GIC158	BPW-085	GIC222	BPW-099	GIC342	BPW-290
SU.352	BPW-070	GIC159	BPW-111	GIC223	BPW-018	GIC343	BPW-285
SU.353	BPW-050	GIC160	BPW-293	GIC228	BPW-001	GIC344	BPW-311
SU.357	BPW-130	GIC160	BPW-180	GIC229	BPW-295	GIC345	BPW-289
SU.361	BPW-049	GIC161	BPW-180	GIC236	BPW-058	GIC346	BPW-286
SU.362	BPW-053	GIC161	BPW-293	GIC237	BPW-060	GIC348	BPW-021
SU.364	BPW-127	GIC162	BPW-012	GIC238	BPW-158	GIC350	BPW-019
SU.365	BPW-129	GIC164	BPW-025	GIC240	BPW-045	GIC356	BPW-006
SU.366	BPW-124	GIC165	BPW-025	GIC242	BPW-002	GIC358	BPW-051
SU.368	BPW-114	GIC168	BPW-039	GIC242	BPW-005	GIC359	BPW-051
SU.372	BPW-299	GIC169	BPW-040	GIC243	BPW-006	GIC360	BPW-098
SU.373	BPW-074	GIC171	BPW-162	GIC244	BPW-054	GIC361	BPW-300
SU.374	BPW-057	GIC172	BPW-003	GIC247	BPW-086	GIC364	BPW-185
SU.376	BPW-138	GIC174	BPW-248	GIC248	BPW-077	GIC365	BPW-149
SU.377	BPW-102	GIC175	BPW-131	GIC250	BPW-143	GIC366	BPW-312
SU.379	BPW-298	GIC176	BPW-071	GIC251	BPW-186	GIC372	BPW-305
SU.380	BPW-314	GIC177	BPW-078	GIC253	BPW-007	GIC373	BPW-179
SU.383	BPW-091	GIC178	BPW-206	GIC257	BPW-021	GIC376	BPW-080
SU.384	BPW-139	GIC178	BPW-039	GIC258	BPW-021	GIC377	BPW-032
SU.385	BPW-100	GIC180	BPW-040	GIC258	BPW-193	GIC387	BPW-035
SU.387	BPW-135	GIC184	BPW-003	GIC259	BPW-021	GIC389	BPW-101
SU.388	BPW-087	GIC185	BPW-096	GIC262	BPW-164	GIC390	BPW-092
SU.389	BPW-106	GIC186	BPW-090	GIC263	BPW-177	GIC398	BPW-003
SU.390	BPW-105	GIC187	BPW-043	GIC264	BPW-016	GIC404	BPW-011
SU.391	BPW-165	GIC188	BPW-055	GIC265	BPW-134	GIC407	BPW-015
SU.392	BPW-073	GIC188	BPW-117	GIC266	BPW-029	GIC408	BPW-287
SU.396	BPW-308	GIC189	BPW-226	GIC267	BPW-044	GIC410	BPW-291
SU.398	BPW-295	GIC190	BPW-113	GIC268	BPW-076	GIC436	BPW-050
SU.400	BPW-095	GIC192	BPW-112	GIC269	BPW-088	GIC470	BPW-139
SU.406	BPW-309	GIC193	BPW-014	GIC270	BPW-063	GIC471	BPW-100
SU.412	BPW-304	GIC194	BPW-021	GIC271	BPW-079	GIC473	BPW-165
SU.413	BPW-303	GIC196	BPW-184	GIC272	BPW-056	GIC476	BPW-308
		GIC197	BPW-246	GIC273	BPW-181	GIC5002	BPW-294
		GIC198	BPW-002	GIC274	BPW-062	GIC5017	BPW-294
		GIC199	BPW-288	GIC275	BPW-038	GIC5021	BPW-288

N.B.: I CODICI O.E. ED IL LORO TESTO SONO RIPORTATI SOLO A TITOLO INDICATIVO
THE O.E. CODES AND THEIR TEXT ARE REPORTED ONLY FOR INDICATIVE PURPOSE

VALEO	CODICE (CODE)	WOKING	CODICE (CODE)	WOKING	CODICE (CODE)	X-ENERGY	CODICE (CODE)
431821	BPW-054	001001	BPW-054	001084	BPW-047	X70101	BPW-217
431822	BPW-126	001002	BPW-025	001085	BPW-099	X70104	BPW-054
431825	BPW-012	001006	BPW-302	001087	BPW-086	X70111	BPW-126
431826	BPW-025	001009	BPW-012	001088	BPW-077	X70112	BPW-203
431827	BPW-126	001010	BPW-292	001090	BPW-265	X70125	BPW-252
431828	BPW-025	001014	BPW-126	001092	BPW-288	X70133	BPW-292
431831	BPW-085	001015	BPW-126	001093	BPW-285	X70156	BPW-306
431833	BPW-039	001016	BPW-126	001094	BPW-286	X70158	BPW-085
431834	BPW-175	001016	BPW-203	001095	BPW-018	X70159	BPW-111
431835	BPW-040	001017	BPW-040	001096	BPW-001	X70160	BPW-180
431836	BPW-292	001018	BPW-039	001098	BPW-158	X70161	BPW-293
431838	BPW-111	001022	BPW-111	001101	BPW-088	X70162	BPW-012
431845	BPW-301	001023	BPW-206	001102	BPW-062	X70164	BPW-025
431847	BPW-206	001024	BPW-085	001103	BPW-056	X70168	BPW-039
431850	BPW-126	001026	BPW-306	001104	BPW-067	X70169	BPW-040
		001028	BPW-292	001105	BPW-059	X70171	BPW-162
		001029	BPW-175	001106	BPW-027	X70174	BPW-248
		001030	BPW-180	001108	BPW-036	X70175	BPW-131
		001032	BPW-248	001109	BPW-079	X70176	BPW-071
		001033	BPW-306	001111	BPW-205	X70177	BPW-078
		001036	BPW-293	001112	BPW-144	X70178	BPW-206
		001037	BPW-226	001113	BPW-068	X70185	BPW-096
		001040	BPW-014	001114	BPW-065	X70186	BPW-090
		001041	BPW-021	001115	BPW-134	X70187	BPW-043
		001043	BPW-007	001117	BPW-016	X70188	BPW-055
		001046	BPW-307	001118	BPW-013	X70188	BPW-117
		001047	BPW-126	001119	BPW-044	X70190	BPW-113
		001048	BPW-071	001120	BPW-029	X70192	BPW-112
		001049	BPW-078	001123	BPW-005	X70193	BPW-014
		001050	BPW-131	001148	BPW-178	X70194	BPW-021
		001051	BPW-154	001156	BPW-178	X70196	BPW-184
		001052	BPW-040	001190	BPW-169	X70197	BPW-246
		001053	BPW-107			X70198	BPW-002
		001054	BPW-096			X7020001	BPW-307
		001055	BPW-043			X70202	BPW-107
		001056	BPW-055			X70202	BPW-154
		001057	BPW-113			X70203	BPW-004
		001058	BPW-112			X70206	BPW-084
		001060	BPW-184			X70207	BPW-028
		001063	BPW-090			X70208	BPW-227
		001065	BPW-081			X70210	BPW-037
		001066	BPW-084			X70213	BPW-132
		001067	BPW-028			X70214	BPW-204
		001068	BPW-227			X70218	BPW-047
		001069	BPW-117			X70223	BPW-018
		001070	BPW-037			X70236	BPW-058
		001071	BPW-061			X70240	BPW-045
		001073	BPW-132			X70242	BPW-005
		001074	BPW-204			X70248	BPW-077
		001075	BPW-141			X7024801	BPW-288
		001076	BPW-004			X70264	BPW-016
		001077	BPW-006			X70265	BPW-134
		001080	BPW-058			X70266	BPW-029
		001081	BPW-128			X70267	BPW-044
		001082	BPW-296			X70268	BPW-076

N.B.: I CODICI O.E. ED IL LORO TESTO SONO RIPORTATI SOLO A TITOLO INDICATIVO
THE O.E. CODES AND THEIR TEXT ARE REPORTED ONLY FOR INDICATIVE PURPOSE



Japanparts®

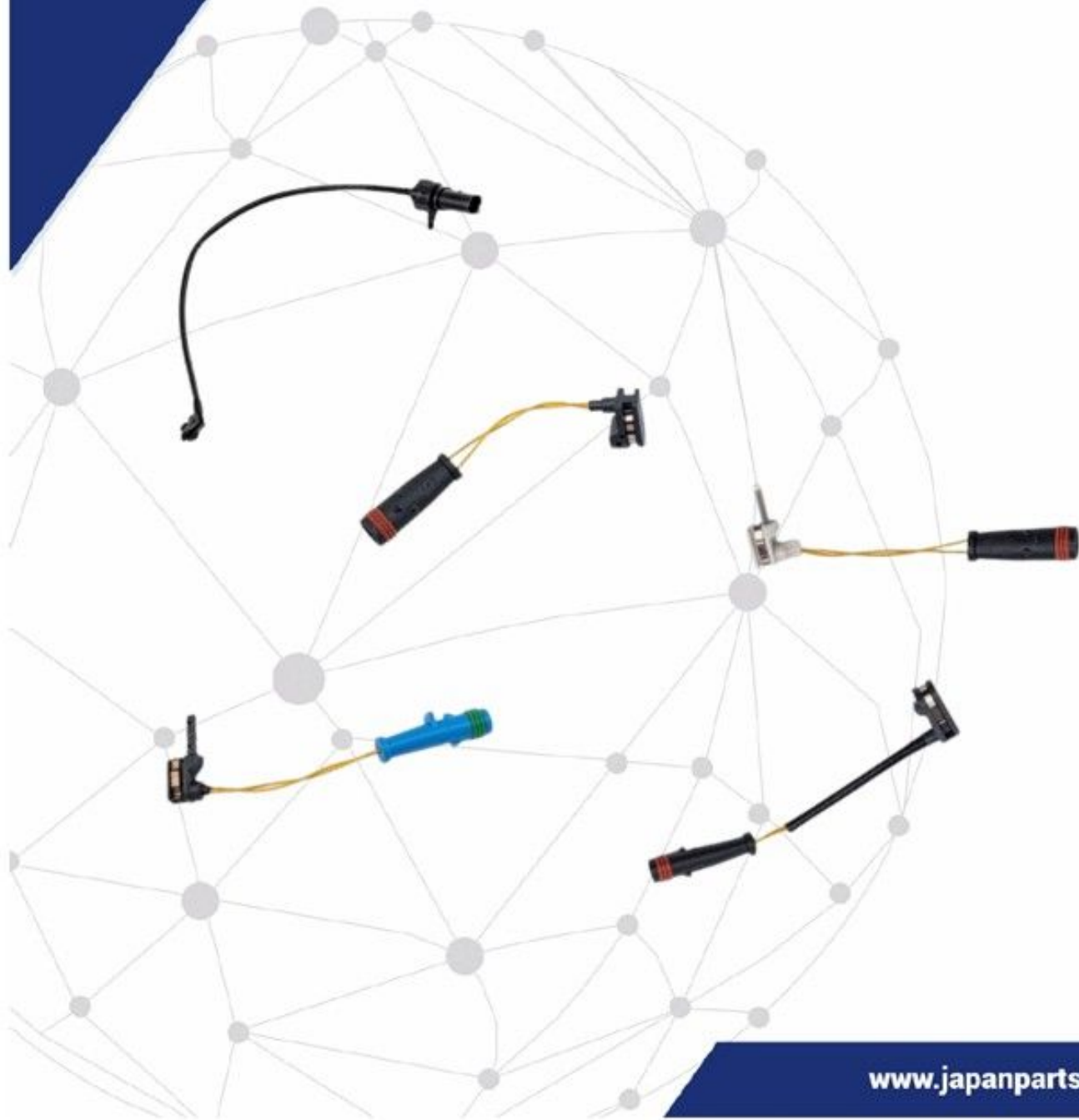

www.japanparts.eu